

## DATA ARTIKEL ILMIAH

Judul	: An adaptive IMC-MPC controller for improving LFC performance
Penulis	: Adelhard Beni Rehiara; He Chongkai; Yutaka Sasaki; Naoto Yorino; Yoshifumi Zoka
Abstrak	: Load frequency control becomes one of the important parts in a power system since frequency deviation is a crucial issue in power system stability. This paper proposed a new IMC controller by combining an adaptive model with MPC controller. A three area power system is chosen to test this controller. Result of simulation show that this new controller has good response in handling the frequency deviation by reducing the peak responses of the prime mover.
Keywords	: IMC, MPC, LFC, Power system
Judul Prosiding	: 2017 IEEE Innovative Smart Grid Technologies - Asia (ISGT-Asia)
Tahun Terbit	: 11 June 2018
Tempat Pelaksanaan	: Auckland, New Zealand
Alamat web	: <a href="https://ieeexplore.ieee.org/document/8378403">https://ieeexplore.ieee.org/document/8378403</a>
Kategori	: Konferensi Internasional
SJR	: -



# ISGT ASIA 2017

Auckland, New Zealand, 4th to 7th, December 2017



## Smart Grid for Smart Community



### ISGT Programme

- Executive Round Table/  
Plenary & Panel Sessions
- Tutorial & Poster Sessions
- Technical & Forum  
Sessions
- Student, Young  
Professionals and  
Women in Power  
Program
- Trade Exhibits, Tours  
& Networking



## ISGT ASIA 2017 LOCAL ORGANIZING COMMITTEE

**Nirmal Nair***University of Auckland*General Chair  
Sponsorship Chair  
Webmaster**Ramesh Rayudu***Victoria University of Wellington*General Co-Chair  
Awards Chair**Tek Tjing Lie***Auckland University of Technology*Technical Chair  
Presentation Chair**Ramon Zamora***Auckland University of Technology*Technical Co-Chair  
Presentation Co-Chair**Nyuk-Min Vong***Transpower*

Industry Chair

**Waqar Qureshi***Mercury NZ*Finance Chair  
Industry Co-Chair  
WiP/YP/Student Program Chair**Jasleen Kaur***Beca*Women in Power  
Coordinator**Neville Watson***University of Canterbury*

Tutorial Chair

**Piyush Verma***GGGI*Student Program Chair  
Publicity Chair**Nasser Usman Farrooqui***University of Auckland*

Secretary

**Nilesh Modi***AEMO*Student Support Chair  
WiP/YP/Student Program Co-Chair**Linda Chhim**

Event Manager

**Adithya Murthy***University of Auckland*

Local Support Chair

**Atif Nauman**

Web master



**Ebad Ur Rehman**  
*University of Auckland*  
Local Support Co-Chair  
Handbook Coordinator



**Safa Al-Sachit**  
*University of Auckland*  
Poster/Forum Support  
Chair



**Mohammad Sanjari**  
*University of Auckland*  
Session Chair



**Leo Yang LI**  
*University of Auckland*  
Session Co-Chair

### VOLUNTEERS



**Duncan Maina**  
Volunteer



**Sainbold Saranchimeg**  
Volunteer



**Mohammed Aldarwesh**  
Volunteer



**Ting Guo**  
Volunteer

### IEEE PES



**Patrick P. Ryan**  
*IEEE PES*  
Executive Director



**Dean Sharafi**  
*AEMO*  
IEEE PES R10 (Asia-Pacific) Representative



**C. Y. Chung**  
*University of Saskatchewan*  
IEEE PES Member-at-Large  
Global Outreach



**Thomas W. Mayne**  
*Lacombe, LA, USA*  
IEEE PES Vice-President Meetings

A Comprehensive Three-Phase Load Flow Method for Integrated MV and LV Distribution Networks.....1	Yang Fu, Xiaoming Zhou, Xiangjing Su, Peter Wolfs & Mohammad A.S. Masoum
Optimal HVAC Scheduling Using Phase-Change Material as a Demand Response Resource.....6	Donald Azuatalam, Sleiman Mhanna, Archie Chapman & Gregor Verbic
An Interval Voltage Control Method Using Adaptive Genetic Algorithm.....11	Cong Zhang, Haoyong Chen, Zipeng Liang & Dong Hua
Load Flow Analysis of Hybrid AC-DC Power System with Offshore Wind Power.....16	Debasish Dhua, Shaojun Huang & Qiuwei Wu
Cooperative Control of Distributed Heterogeneous Energy Storage Devices with Virtual Impedance.....21	Runfan Zhang, Branislav Hredzak & Thomas Morstyn
Online Energy Management Strategy for Islanded Microgrids with Feedback Linearizing Inner Controllers.....27	Carlos Andres Macana Moreno, Sheik Mohiuddin, Hemanshu Pota & Md Apel Mahmud
An Interval DC Power Flow Analysis through the Optimizing-scenarios Method.....33	Cong Zhang, Haoyong Chen, Zipeng Liang & Dong Hua
Real-Time Transient Stability Assessment Based on Deep Recurrent Neural Network.....38	Le Zheng, Wei Hu, Kaiyuan Hou, Xingwei Xu & Guanghui Shao
Trading strategy for decentralized energy resources in sequential electricity markets: A Swiss case study.....43	Xuejiao Han, Evaggelos Kardakos & Gabriela Hug
A Morphological Filter-based Local Prediction Method with Multi-variable Inputs for Short-Term Load Forecast.....50	Xiuzhen Ye, Tianyao Ji, Mengshi Li & Qinghua Wu
The Sizing of Battery Energy Storage for the Mitigation of Slow and Fast Fluctuations in Rooftop Solar PV Output.....56	Prabha Ariyaratna, Kashem Muttaqi & Danny Sutanto
Real Time Stability Enhancement for Islanded Microgrids.....62	Anusuya Arunan, Jayashri Ravishankar & Ambikairajah Eliathamby
Improvement of Supply Restoration in Multi-Spare-Feeder Active Distribution Grids using IEC 61850...67	Pouya Jamborsalamati, Abhinav Sadu, Ferdinanda Ponci, Antonello Monti & M. J. Hossain
Switching Performance Optimization for a Hybrid AC/DC Microgrid using an Improved VSG Control Strategy.....72	Jiannan Liu, M. J. Hossain & Junwei Lu
Effectiveness of Updating the Parameters of the Volt-VAR Control Depending on the PV Penetration Rate and Weather Conditions.....77	Yuta Takasawa, Satoru Akagi, shinya yoshizawa, Hideo Ishii & Yasuhiro Hayashi
Installed Generator Capacity Determination Method with Variable Weather-based SOC Operation for Island-alone Off-grid System.....82	Souichiro Kama, Jun Yoshinaga, Wataru Hirohashi, Yasuhiro Hayashi, Masato Watanabe & Hikaru Takigasaki
Evaluation of Energy-Loss Minimum Operation Using Real Measurements and Network Data.....87	Shingo Uchiyama, Yuji Takenobu, Jun Yoshinaga, Yasuhiro Hayashi, Masato Watanabe & Ryota Yamamoto
Design Improvements of the Resistive Shunt Online Impedance Analyser.....93	Cornelis Kikkert & Shucheng Zhu
Simulation Study of Integrated Smart Energy Systems.....98	Dezhi Dong, Mengjie Li, Gang Chen, Wei Ge & Yixue Chen
Coordinated Operation Scheduling Method for BESS and Thermal Generators based on Photovoltaic Generation Forecasts Released Every Several Hours.....104	

Daiki Kobayashi, Taisuke Masuta & Hideaki Ohtake	
Clustering-based Decentralized Optimization Approaches for DC Optimal Power Flow.....	110
Kai Zhang, Sarmad Hanif & Dante Fernando Recalde Melo	
Effect of an Electric Vehicle Bus Network on Guwahati Grid.....	116
Krishnarti De, Suman Majumder, Praveen Kumar & Ramesh Rayudu	
Research on Tripping and Reclosing Strategy and Quasi-Three-Phase Operation of Double Circuit Lines on the Same Tower.....	122
Shilong Li, Wei Chen, Xianggen Yin & Deshu Chen	
Daily Game Theoretical Management of a Connected Industrial Microgrid	128
Charline Stevanoni, François Vallée, Zacharie De Grève & Olivier Deblecker	
Service-Based General Power System Data Exchange Mode.....	133
Haifeng Huang, Hong Zhang, Xiaolu Li, Zhiqiang Yao & Fang Yu	
An Educational Open-Source Market Modeling Toolbox for Future Grid Studies.....	139
Aaron Ramsden & Gregor Verbic	
Simulation Model of Three-phase PWM Rectifier Charging Station and Harmonic Analysis on Grid.....	144
Bin Wu, Hongkun Chen, Guanhui Guan, Tong Ding & Li Yin	
Research on HVDC Transmission Power Scheduling on the Background of Asynchronous Interconnection.....	150
Yiping Chen, Xiaodong Zheng, Haoyong Chen, Yong Zhang, Jizhong Zhu & Julong Chen	
Fault Ride-through Capacity Enhancement of Doubly Fed Induction Generator Based Wind Farm by Saturated Core Fault Current Limiter.....	155
Jiaxin Yuan, Zehua Huang, Baichao Chen, Liangliang Wei & Gang Xue, Xin Yan	
PEA Microgrid Design for Coexistence with Local Community and Environment: Case Study at Khun Pae Village Thailand.....	160
Tirapong Kasirawat, Patompong Boonsiri & Titti Saksornchai	
Performance Comparison of Integrated Magnetics Used in LLC Resonant DC-DC Converter for Low Voltage Energy Storage System.....	165
Wayne Water & Junwei Lu	
Identification and Tuning of Dominant Controller Parameters of DFIG with Damping Control.....	170
Ganesh P. Prajapat, Nilanjan Senroy & Indra Narayan Kar	
Resilience-Oriented Microgrids: A Comprehensive Literature Review.....	176
Yuan Chi & Yan Xu	
Electricity Theft Detecting Based on Density-Clustering Method.....	182
Kedi Zheng, Yi Wang, Qixin Chen & Yuanpeng Li	
Inverter Based Multi-objective Robust Volt/Var Regulation for Distribution Networks.....	188
Ruipeng Xu, Yan Xu & Wei Shen	
Multi-Area Generation Adequacy and Capacity Credit in Power System Analysis.....	194
Egill Tomasson & Lennart Söder	
Review of Clustering Algorithms for Microgrid Formation.....	200
Derek Li Kwok Cheong, Tyrone Fernando, Herbert Iu, Mark Reynolds & James Fletcher	
Studying the influence of coordinated EV charging on power system operating risk.....	206
Mingzhi Zhang, Lingfeng Wang & Chunlin Guo	
A Communication-enhanced Price-based Control Scheme for HVAC Systems.....	214
Fernandez, Pouya Jamborsalamati, M. J. Hossain & Uzma Amin	
An Economic Optimization for BESS Sizing in a Hybrid PV and Wind Power Plant.....	220
Yuqing Yang, Stephen Bremner, Chris Menictas, Ke Meng, Zhao Yang Dong & Merlinde Kay	
Equivalent Model of Wind Farm Based on DBSCAN.....	226
Pingping Han, Yu Xia, Yan Zhang & Kui Luo	

An Evaluation Method for Required Operating Reserve of a Power System with High Penetration of Variable Renewable Generation.....	232
Yuki Izumida, Shigeru Bando & Hiroshi Asano	
Economic Feasibility of Stand-alone Power Systems for Existing Distribution Networks in Rural Areas.....	238
James Fletcher, Tyrone Fernando, Herbert Iu, Mark Reynolds & Shervin Fani	
Towards a Sustainable, Economic and Reliable Power Grid for Australia.....	243
Cornelis Kikkert	
An Investigation into Improving the Measurement of the Water Content of Transformer Electrical Insulation.....	249
Daniel Martin, Tapan Saha, Josh Hockey, Greg Caldwell, Gary Buckley & Srinivasan Chinnarajan	
Probabilistic Small Signal Stability Analysis of Autonomous Wind-Diesel Microgrid.....	253
Awan Krismanto & Nadarajah Mithulananthan	
Hardware Lab Tests on Dynamic Frequency Support by Converters Applying Different Inertia Constants.....	259
Stefan Henninger, Ludwig Doering & Johann Jaeger	
Economic Operation of Industrial Microgrids with Multiple Kinds of Flexible Loads.....	265
Junyi Shi, Pengcheng Cui, Fushuan Wen, Linrun Guo & Yusheng Xue	
Method for Generating Switching Operation Sequence of Distribution Network in Response to 10kV Bus Voltage Loss.....	271
Shaohui Zhang, Mengru Ma, Yuehao Yan, Shuaiwen Guo, Jiandong Jiang & Wei Bao	
DC Voltage Droop Control Structures and its Impact on the Interaction Modes in Interconnected AC-HVDC systems.....	277
Florian Thams, Spyros Chatzivasileiadis & Robert Eriksson	
Network topology identification algorithm based on adjacency matrix.....	283
Shaohui Zhang, Shuaiwen Guo, Yuehao Yan, Mengru Ma, Jiandong Jiang & Wei Bao	
Evaluation of the Energy Model of a Horizontally-Mounted Electric Water Heater Through Internal Temperature Measurement.....	288
LL Leeuwner, Nico Naudé, Marcel Roux & MJ Booyesen	
Machine Learning Method for Day Classification to Understand Thermostatically Controlled Load Demand.....	295
Ying Guo & Nariman Mahdavi	
Multi-Terminal HVDC Fault Current Analysis During Line to Ground Fault.....	300
Muhammad Haroon Nadeem, Nengling Tai, Xiaodong Zheng, Wentao Huang & Mehr Gul	
An Adaptive Overcurrent Protection Scheme for Microgrids based on Real Time Digital Simulation.....	305
Anurag Sharma, Kailun Zhang, Dhivya Sampath Kumar & D Srinivasan	
Optimal Smart Functions of Large-scale PV Inverters in Distribution Systems.....	311
Van Tu DAO, Hideo Ishii & Yasuhiro Hayashi	
Determination of Optimal Controlled Splitting Time in Power Systems.....	318
Min Cheng, Wentao Yang, Fushuan Wen, Linrun Guo & Yusheng Xue	
MATLAB Applications to Generate Synthetic Electricity Load Profiles of Office Buildings and Detached Houses.....	324
Daniel Brodén, Kaveh Paridari & Lars Nordström	
Optimal Design of Frequency-based Synchronization Controller for the VSC-HVDC Station Connected to a Weak AC Grid.....	330
Chunyi Guo, Wei Liu, Chengyong Zhao, Xiufang Jia & Li Qiao	
Rapid Synchronisation Procedure for a Pneumo-Hydraulically Driven Synchronous Generator.....	336
Efim Sturov, Chris Bumby, Ramesh Rayudu & Rod Badcock	
Impact of Electric Vehicle Chargers on Harmonic Levels in New Zealand.....	341



Jeremy Watson & Neville Watson	
Wide-area Optimal Damping Control System Research with Grid and Generators Coordination.....	347
Wei Hu, Yiwei Fu, Yu Dong, Rui Yu & Baisi Liu	
Least Measurement Rejected Algorithm for Robust Power System State Estimation.....	353
Mohammad Shoaib Shahriar & Ibrahim Habiballah	
Demand Response-Based Preventive-Corrective Control against Short-Term Voltage Instability in Power Systems.....	359
Rizhong Kang, Yan Xu, Zhao Yang Dong & David Hill	
AC Source vs DC Source:Charging Efficiency in Battery Storage Systems for Residential Houses.....	364
Junaid Qureshi, Tek Tjing Lie, Kosala Gunawardane, Nihal Kularatna & Waqar Qureshi	
A Multiple Layer Power Security Design for a Typical Microgrid Infrastructure with Improved Reliability and Sustainability.....	370
Samson Shih, Xin Kong, Meng Hwee Chia, Ashwin M Khambadkone, Hian Koon Chua, Siaw Peng The & Hang Kiang Tan	
Multivariate Prediction Intervals for Photovoltaic Power Generation.....	376
Faranak Golestaneh & HB Gooi	
Correcting Forecast of Utility's Demand with Increasing Solar PV Penetration.....	381
Vishnu P. Menon, Smita Lokhande & Yogesh Bichpuriya	
Investigation of Transient Stability of a Power Network with Solar-PV Generation: Impact of Loading Level & Control Strategy.....	387
Aratrika Ghosh, Ragini Patel, Manoj Datta & Lasantha Meegahapola	
Enabling BES in Large PV Plant for Stability Enhancement of Power Systems with high RES.....	393
Herlambang Setiadi, Awan Krismanto & Nadarajah Mithulanathan	
Using PV with Borehole Pumped Hydro Storage Systems for Small Farming Activities in South Africa.....	399
Kanzumba Kusakana	
Bridging the transition to DC distribution: a hybrid microgrid for residential apartments.....	405
Gurupraanesh Raman, Gururaghav Raman, Jimmy Chih-Hsien Peng & Weidong Xiao	
Load Leveling Effects by Massively Introduced Residential Battery Storage Systems.....	411
Junpei Harasawa & Takashi Ikegami	
Hybrid Real-Time Simulator for Evaluation of Direct Load Control to Assist Power System Control.....	417
Hiroumi Saitoh & Dai Orihara	
The Effects of Multi-Distributed Generator on Distribution System Reliability.....	422
Atthapol Ngaopitakkul & Chaiyan Jettanasen	
CIM compliant multiplatform approach for cyber-physical energy system assessment.....	428
Minh Tri LE, Van Hoa Nguyen, Quoc Tuan Tran, Yvon Besanger, Thierry Braconnier, Antoine Labonne & Hervé BUTTIN	
Economic Analysis of Multi-service Provision from PV and Battery Based Community Energy Systems.....	434
Han Wang, Nicholas Good & Pierluigi Mancarella	
Optimisation of Battery Energy Storage Capacity for a Grid-Tied Renewable Microgrid.....	440
Rasoul Garmabdari, Mojtaba Moghimi, Fuwen Yang, Junwei Lu, Hui Li & Zilong Yang	
Static Performance Comparison of Prominent Synchrophasor Algorithms.....	446
Chathura Thilakarathne, Lasantha Meegahapola & Nuwantha Fernando	
Estimation of Vehicle-to-Grid Service Capacity at Business Premises Using Aggregate Model.....	452
Md Shariful Islam, Junainah Sardi, Awan Krismanto & Nadarajah Mithulanathan	
Fuzzy Logic Improved Washout Filter-Based Method for Voltage Restoration in DC Microgrids.....	458
Ruihao Song, Branislav Hredzak, Toan Phung & Karanayil Baburaj	
Hybrid Energy Storage Retrofit for Standalone Photovoltaic-Battery Residential Energy System.....	463



Wenlong JING, Derrick Ling, Cheanlung Lai, Wallace Shunghui Wong & M. L. Dennis Wong Improved Day-Ahead Predictions of Load and Renewable Generation by Optimally Exploiting Multi- Scale Dependencies.....	469
Jean-François Toubeau, Jérémie Bottieau, François Vallée & Zacharie De Grève FMI Compliant Approach to Investigate the Impact of Communication to Islanded Microgrid Secondary Control.....	474
Tung Lam Nguyen, Quoc Tuan Tran, Raphael Caire, Yvon Bessanger, Tran The Hoang & Van Hoa Nguyen Conversion of Performance Parameters Amongst the South African, EN 12975 and ASHRAE SWH Test Standards.....	480
Shaun Chan Wing, Daniel De Canha & Jan Harm Pretorius Modal Analysis of Grid Connected DFIG with Detailed Structural Modeling of Wind Turbine.....	485
Ganesh P. Prajapat, Nilanjan Senroy & Indra Narayan Kar Managing the design and development of high- performance buildings through integrated design.....	490
Willie Beetge, Daniel De Canha & Jan Harm Pretorius Power-based Distribution Network Tariff of Small Customers in Different Operational Environments – Case Study of Two Networks.....	497
Kimmo Lummi, Antti Rautiainen, Pertti Järventausta, Pirjo Heine, Jouni Lehtinen, Markku Hyvärinen & Johannes Salo Research of Metering Scheme for Self-provided Power Plants Based on Synchronized Clock Signals....	503
Yihang Yang, Yuanrong Xu, Wenzhe Duan, Yuehao Yan & Yiwei Zhai An Adaptive IMC-MPC Controller for Improving LFC Performance.....	508
Adelhard Rehiara, He Chongkai, Yutaka Sasaki, Naoto Yorino & Yoshifumi Zoka Impact of Photovoltaic Penetration on Small Signal Stability considering Uncertainties.....	514
Samundra Gurung, Sumate Naetiladdanon & Anawach Sangswang Hosting Capacity of Large Scale PV Power Station in Future Distribution.....	520
Daisuke Iioka, Koya Miura, Mai Machida, Shota Kikuchi, Jun Tamura, Masaki Imanaka, Jumpei Baba, Masaaki Takagi & Hiroshi Asano Sustainable Electric Vehicle – Prosumer Framework and Policy Mix.....	526
Kirsi Kotilainen, Saku J. Makinen & Jussi Valta Availability and Resiliency Analysis of Modern Distribution Grids Using Stochastic Reward Nets.....	532
Kieran Morris, Dong Seong Kim, Alan Wood & Graeme Woodward Networks Hosting Capacity Analysis of Many Distributed Photovoltaic Systems in Future Distribution Networks .....	537
Shota Kikuchi, Mai Machida, Jun Tamura, Masaki Imanaka, Jumpei Baba, Daisuke Iioka, KOYA MIURA, Shota Kikuchi, Masaaki Takagi & Hiroshi Asano Three-Level Co-optimization Model for Generation Scheduling of Integrated Energy and Regulation Market.....	542
Hongbo Sun, Yusuke Takaguchi, Daniel Nikovski & Hiroyuki Hashimoto Decision-making of Voltage Control Strategy for Distribution Network after Large-scale PV Participation.....	548
Jinxi Dong, Yiming Xu, Xiusheng Ren, Zheng Wang, Jiawei Wang, Zeyuan Shen & Zhiqiang Wang Coordinated Generation and Transmission Planning Based on EDA/DA Algorithm Considering Wind Power Integration.....	555
Jinxi Dong, Hui Han, Xiusheng Ren, Zheng Wang, Jiawei Wang & Haibo Zhao A Feature based Distributed Machine Learning for Post Fault Restoration of a Microgrid under Different Stochastic Scenarios.....	561
Miftah Al Karim, Jonathan Currie & Tek Tjing Lie	

Statistical Analysis of the German Electricity Market in Presence of Renewables.....	567
Hamid Aghaie	
Intelligent Edge Analytics for Load Identification in Smart Meters.....	572
Tharmakulasingam Sirojan, Toan Phung & Ambikairajah Eliathamby	
Optimal PMU Placement for Distribution Networks.....	577
Abdul Aziz Mabaning, Jordan Rel Orillaza & Alexandra von Meier"	
Load Forecasting Based on Short-term Correlation Clustering.....	583
Shun Tao, Yongtong Li, Xiangning Xiao & Liting Yao	
Cost-effective Analysis of Countermeasures for Solar Photovoltaic Systems in Distribution Networks.....	590
Masaaki Takagi, Shigeru Bando, Naoto Tagashira, Yutaka Nagata, Hiroshi Asano, Masahiro Ishihara, Hideo Nogiwa, Daisuke Iioka, Mai Machida, Shota Kikuchi, Masaki Imanaka & Jumpei Baba	
Consideration of effect of excitation power of self-excitation AVR on synchronous stability.....	596
Hiroki Osawa, Ori Sakamoto & Tanzo Nitta	
Challenges to overcurrent protection devices in PV array during winter and low irradiation conditions in Australia.....	602
Amit Dhoke & Adrian Mengede	
Optimization of Isolated Microgrids with Cost and Reliability Targets.....	608
Daniella Fronza, Kim Rosendo & Michael Pedrasa	
A Development of A Single-phase Synchronous Inverter for Grid Resilience and Stabilization.....	614
Shinya Sekizaki, Yutaka Sasaki, Naoto Yorino, Yoshifumi Zoka, Yuki Nakamura & Ichiro Nishizaki	
Multi-Functional DSTATCOM to Improve Power Quality and Energy Efficiency in Petrochemical Plant.....	620
Srinivasarao Kamala, Dastagiri Reddy Bonthapalle, Sanjib Kumar Panda & Gehan Amaratunga	
Demand Power Forecasting with Data Mining Method in Smart Grid.....	626
Seunghyeon Park, Sekyung Han & Yeongik Son	
Control Strategy of Wind Turbine Generator with Storage in Short-term Dispatch Scheme.....	632
Surina Mat Suboh & Rahul Sharma	
Optimal capacity planning for heat storage in thermal power plant to accommodate wind power.....	638
Zhiqiang Wang, Xuefeng Tian, Shan Wang, Ning Wang & Benran Hu	
Analysis of Fault Characteristics in DC Microgrids for Various Converter Topologies.....	645
Anju Meghwani, S Chakrabarti, S. Srivastava & S. Anand	
Development of a quick-response superconducting generator model for electromagnetic transient analyses of power systems.....	651
Reiko Kato & Ori Sakamoto	
Optimal Design of Electric Vehicle Charging Station Integrated with Renewable DG.....	656
Tasneim Aldhanhani, Ahmed Al-Durra & Ehab El-Saadany	
Smart Grid Protection through Self-Healing.....	662
Chathurika Chandraratne, R. T. Naayagi & Thillainathan Logenthiran	
Increasing the Efficiency of a Virtual Battery Storage Providing Frequency Containment Reserve Power by Applying a Clustering Algorithm.....	668
Jonas Schlund, David Steber, Peter Bazan & Reinhard German	
Resilient Distributed Generation Dispatch in Multi-Microgrid Systems.....	676
Fredmar Asarias & Michael Pedrasa"	
BESS life span evaluation in terms of battery wear through operation examples of BESS for frequency Regulation.....	682
Jeong Hyeon Choi, Jo Hyeondeok & Sekyung Han	
A Dynamic Programming Framework for Optimal Home Scheduling.....	687
Anupama Kowli, Joel Jose, Vivek S. Borkar & Imthias Ahamed T. P.	

PV and Battery Sizing for User's Defined Energy Independence.....	693
Sarute Srisontisuk & Naebboon Hoonchareon	
Multi-objective DSTATCOM Placement Based on Sensitivity Analysis and Genetic Algorithm in Unbalanced MV Distribution Networks.....	699
Xiangjing Su, Huanhuan Liu, Yang Fu & Peter Wolfs	
Variability Study of a Utility-scale PV Plant in the Fringe of Grid, Australia.....	704
Feifei Bai, Ruifeng Yan & Tapan Saha	
Development of Frequency Control Performance Evaluation Criteria of BESS for Ancillary Service: A case study of Frequency Regulation by KEPCO.....	709
Jo Hyeondeok, Jeong Hyeon Choi, Agyeman Kofi Afrifa & Sekyung Han	
Methodology for Optimized Power Quality Compensation in Networks with Electrified Railways.....	714
Yizheng Xu, Hongying Peng, Xing Zhang, Lixiang Sun, Yulong Che, Haoyue Chen & Jiwei Zheng	
Saving on household electric water heating: What works and how much?.....	719
Philip Nel, MJ Booysen & Brink Van Der Merwe	
WAMS based Dynamic States and Parameters Estimation using Least Squares Estimation and Unscented Kalman Filter.....	725
Rajiv Jha & Nilanjan Senroy	
Energy Independence of Energy Trading System in Microgrid.....	731
Minkyung Kim, Sangdon Park, Joohyung Lee & Junkyun Choi	
Assessment of Cut-Sets for Generator Coherency based Power System Islanding Approaches.....	735
Mohammed Abdallatif, Andreas Kubis, Sebastian Schramm, Jürgen Götze & Christian Rehtanz	
Solid State Transformer Control Aspects for Various Smart Grid Scenarios.....	740
Naga Brahmendra Yadav Gorla, Sandeep Kolluri & Sanjib Kumar Panda	
Demand Response for Increased Grid Flexibility: The case of Finland.....	746
Petri Valtonen, Goncalo Mendes & Samuli Honkapuro	
Battery-Assisted Load Frequency Control Coordinated with Economic Load Dispatching.....	752
Dai Orihara & Hiroumi Saitoh	
Integration of Renewables in Singapore: Ramp Rate Support using Electric Vehicles.....	757
Tobias Massier & Dante Fernando Recalde Melo	
Formal Verification of Demand Response based Home Energy Management Systems in Smart Grids.....	763
Adnan Yaqoob Salik, Muhammad Usama Sardar, Osman Hasan, Syed Rafay Hasan & Falah Awwad	
Solid State Transformer Parallel Operation with a Tap Changing Line Frequency Transformer.....	769
Nuwantha Fernando, Lasantha Meegahapola & Chathura Thilakarathne	
Power Transaction Management amongst Coupled Microgrids in Remote Areas.....	775
Munira Batool, Syed Islam & Farhad Shahnai	
Association Rules Analysis between Power System Operating States and Transient Stability Margin....	781
Fang Shi, xiongwei hu, Zhihong Yu, Yanhao Huang & Guangming Lu	
The Operating Feature Research on the Global Energy Interconnection: A Review.....	786
Fang Shi, Hengxu Zhang, Changgang Li, Xiaohan Shi, Lei Zhang & Yong Zhang	
Lightning protection of MEA's 24 kV distribution lines Using overhead ground wires.....	793
Pornchai Sestasombut & Atthapol Ngaopitakkul	
Fault-Tolerant Converter for Future Offshore Wind Farm HVDC Networks.....	798
R.T. Naayagi & S.K. Panda	
Optimal Operation of Fuel Cell and Electrolyzer in Household Hybrid System by Stochastic Programming.....	803
Koki Hashimoto & Koji Kawahara	
Design of Controller Using Reduced Order Modeling for LED Driver Circuit.....	809
Afzal Sikander, Piyush Verma, Nitish Patel & Nirmal Nair	

Impact of the Solar Photovoltaic (PV) Generation on Long-Term Voltage Stability of a Power Network.....	814
Enkhtsetseg Munkhchuluun & Lasantha Meegahapola	
Mitigation of Residual Flux for High-Temperature Superconductor (HTS) Transformer by Controlled Switching of HTS Breaker Arc Model.....	820
Aasim Ullah, Tek Tjing Lie, Kosala Gunawardane & Nirmal Nair	
A New Control Approach for Improved Dynamic Performance of MMC based HVDC Subsea Power Transmission System.....	826
Sandeep Kolluri, Naga Brahmendra Yadav Gorla, Rajesh Sapkota & Sanjib Kumar Panda	
MMC based Multi-terminal HVDC Subsea Power Transmission System with Integration of Offshore Renewable Energy.....	832
Rajesh Sapkota, Sandeep Kolluri, Jeevan Adhikari & Sanjib Kumar Panda	
PMU based WAMC application in Multi-modular HVDC Based Large Scale Solar System.....	838
Saifal Talpur & Tek Tjing Lie	
Recent Advancements on Power System Restoration.....	841
Duncan Maina & Nirmal Nair	
Probing the Impact of Voltage Sags and Swells on Energy-Efficient LED Streetlights.....	846
Piyush Verma, Nitish Patel, Faizal Hafiz, Ankur Mishra & Nirmal Nair	
Fault Identification in AC and DC Systems Using STFT Analysis of High Frequency Components.....	852
Abhisek Ukil, Yew Ming Yeap, Kuntal Satpathi & Nagesh Geddada	
Congestion Management in Smart Grids using Virtual Power Plants as Flexible Resources.....	858
Min Junhua, Sivanand Nunna & D Srinivasan	
A Multilayer Optimization Scheme to Retain the Voltage and Frequency in Standalone Microgrids.....	864
Md Asaduzzaman Shoeb, Farhad Shahnia & GM Shafiullah	
Microgrid System and Component Evaluation: Mobile Test Platform with Battery Storage.....	870
Gabriel Haines, Nesimi Ertugrul, Graeme Bell & Michael Jansen	
A Combined Control Strategy for Load Management within an Interconnected Nanogrid Network.....	875
Daniel Burmester, Ramesh Rayudu & Winston K.G. Seah	
Impacts of Distributed PV in a Smart Grid using Temperature-Dependent Power Flow.....	880
Arif Ahmed, Fiona Stevens McFadden & Ramesh Rayudu	
Testing and Validation of FTR Results in NZEM.....	886
Bhujanga Chakrabarti, Roger Miller & Ramesh Rayudu	
Techno-Economic Analysis of Hybrid Renewable Energy System for Rural Electrification in India.....	892
Abhi Chatterjee & Ramesh Rayudu	
Influence of Fluid Selection on Synchronous Generators Power Output in Compressed Air Energy Storage Systems.....	897
Efim Sturov, Chris W. Bumby, Ramesh Rayudu & Rod A. Badcock	
Feasibility of Magnetic Signature-based Detection of Low and High Impedance Faults in Low-voltage Distribution Networks.....	903
Anwarul Islam Sifat, Fiona Stevens McFadden, Arif Ahmed, Ramesh Rayudu & Arvid Hunze	
Impact of centralized photovoltaic systems on utility power factor profile using the wavelet variability model.....	909
Michael Emmanuel, Ramesh Rayudu & Ian Welch	
Reconfiguration and Load Shedding for Resilient and Reliable Multiple Microgrids.....	915
Kenneth Martin Atendido & Ramon Zamora	
Effect of Solar PV on Frequency Management in New Zealand.....	920
Nyuk-Min Vong, Shiva Pillay & Victor Lo (Transpower, NZ)	

# An Adaptive IMC-MPC Controller for Improving LFC Performance

Adelhard Beni Rehiara, He Chongkai, Yutaka Sasaki, Naoto Yorino, and Yoshifumi Zoka

Graduate School of Engineering, Hiroshima University, Higashi-Hiroshima, Japan

e-mail: ab-rehiara@hiroshima-u.ac.jp

**Abstract**—Load frequency control becomes one of the important parts in a power system since frequency deviation is a crucial issue in power system stability. This paper proposed a new IMC controller by combining an adaptive model with MPC controller. A three area power system is chosen to test this controller. Result of simulation show that this new controller has good response in handling the frequency deviation by reducing the peak responses of the prime mover.

**Keywords**—IMC, MPC, LFC, Power system.

## I. INTRODUCTION

A power system may consist of generator, transmission and/or distribution line and load. Load that connected to the power system can change every time. This condition will then influence frequency of the system. Load frequency control (LFC) is one of the main parts on power system to maintain the frequency fluctuation of load change. The main function of LFC is to maintain the frequency stable during exchange power on the network where the generator dispatch must satisfy the load demand. For multi area power system, the complexity is increases and so highly dynamic operation will be introduced. Some researchers have previously worked in the area of frequency control i.e. [1] designed an LFC using the model predictive control (MPC) for a multi-area power system including wind turbines, [2] presented a comparison of MPC and PI against a conventional Automatic Generation Control, [3] presented an LFC method based on Fuzzy Logic controller (FLC) and recently [4] discussed total tie line power flow by replacing the LFC model.

Internal Model Control (IMC) and Model Predictive Control (MPC) are well known as model based process controllers. The process control has been influenced since both IMC and MPC were proposed few decades ago and until now the variant of both controllers are increased as well as those performance. The merit of MPC and MPC is the ability to predict the future behavior of the controlled plant based on those internal models. While a mismatch model can reduce both controllers performance. Therefore it will be a challenge to provide a great model for the controllers.

An adaptive model may be a solution to provide perfect model for both IMC and MPC since the model can be updated in a certain time to do corrections for the existing model.

Many previous researches have succeeded to apply the adaptive model into a controller i.e. PI/PID [10]-[11],[14], Fuzzy controller [19], or MPC [22]. The use of internal model has been proposed in [20] by using neural network. In this paper an adaptive IMC controller is built by employing an MPC and an internal model in adaptive scheme to control a load frequency of a power system.

## II. METHODOLOGY

### A. Control Performance

The method to evaluate control performance can be done over time and peak criterions. In this case, peak criterion will be the focus to determine control performance where the criterion is spread into peak overshoot ratio (POR) and decay ratio (DR) of the system step responses. Both POR and DR ratio can be expressed in following equations [7].

$$POR = \frac{fo}{sp} \quad (1)$$

$$DR = \frac{so}{fo} \quad (2)$$

Where  $fo$ ,  $so$ , and  $sp$  are first peak height, second peak height and set point step respectively.

### B. Adaptive Model

As proposed in this research, an adaptive model will be used to provide a perfect model of the plant. Along the simulation, the adaptive model is built by utilizing input and output data. Then the model is generated to a state space model.

In order to realize the adaptive model in MATLAB environment, the state space model can be estimated using `ssest` command. Using this command, a state space model can be generated from a given system identification data by using prediction error minimization (PEM) algorithm. A numerical optimization is used by the PEM algorithm to minimize the cost function. Recently the PEM algorithm in MATLAB environment is only provided with the cost function as follows [23].

$$V_N(G, H) = \sum_{t=1}^N e^2(t) \quad (3)$$

Where  $e(t)$  is the difference between the measured output and the predicted output  $G$  of the model with  $N$  number of samples.

### III. CONTROLLER

#### A. Model Predictive Control

An MPC is a multivariable and iteration based control algorithm that uses a process model, previous control moves and an objective function throughout its prediction horizon to count its optimal control moves. In some condition the objective function should not violate any given constraints of the system. An MPC can be linear or nonlinear which is characterized by the use of its internal model [7].

An IMC controller will build its internal model base on the mathematical model of a plant. A way to build the model is using an orthonormal function while the function can also be applied in dynamic system modeling. As MPC is a type of controller that used a model to predict the behavior of the controlled plant, this function will be used to define its model. Laguerre functions satisfy these properties and also possess simple Laplace transforms.

In general a plant model is built within continuous time framework. To be able to use in discrete time MPC, the model is needed to be discretized within a time sampling.

Laguerre function is built from its network that mainly applied in the system identification study and it is primarily built in continuous time. The function can be transformed to discrete time using z-transformation as shown in (4). The Laguerre function is derived by building its state-space form in (5) and its initial condition in (6), where  $N$  is the length of Laguerre network,  $a$  is called time scaling factor,  $A_l$  is a Toeplitz matrix of parameters  $a$  and  $\beta=(1-a^2)$ , and  $L$  is the Laguerre function's state vector [5], [7].

$$\Gamma N = \frac{\sqrt{1-a^2}}{1-az^{-1}} \left( \frac{z^{-1}-a}{1-az^{-1}} \right)^{N-1} \quad (4)$$

$$L(k+1) = A_l L(k) \quad (5)$$

$$L(0)^T = \sqrt{\beta} \left[ 1 - a \quad a^2 - a^3 \quad \dots (-1)^{N-1} a^{N-1} \right]^T \quad (6)$$

Receding horizon control is done by taking a minimal solution of an objective function  $J$  as in (4).

$$J = \sum_{m=1}^{Np} x(k+m|k)^T Q x(k+m|k) + \eta^T R \eta \quad (7)$$

The control law with optimal gain  $K_{mpc}$  for close loop system can then be obtained in (8).

$$x(k+1) = (A - BK_{mpc})x(k) \quad (8)$$

$$K_{mpc} = L(0)^T \eta \quad (9)$$

$$\Delta u = -K_{mpc}x \quad (10)$$

Where  $Q \in \mathfrak{R}^{ns \times ns}$  is a weighting matrix,  $Np$  is prediction horizon,  $\Delta u$  is control parameter vector,  $R \in \mathfrak{R}^{ni \times ni}$  is a diagonal matrix contains tuning parameters for the desired closed-loop performance and  $\eta \in \mathfrak{R}^{ns \times N}$  is an optimal solution of the parameter vector. The  $ni$  and  $ns$  are the number of input and state variable.

#### B. Internal Model Control

Internal model is a process model that simulates the response of the system in order to estimate the outcome of a system disturbance. An Internal Model Control (IMC) can use the internal model to predict the future output of the plant and also to make correction of the output. This controller can be used to control a plant [9], to tune other controller [17], or to combine with the other controller such as PI/PID [12]-[17], Fuzzy controller [18], [19], Neural Network [22] or MPC [19]-[22].

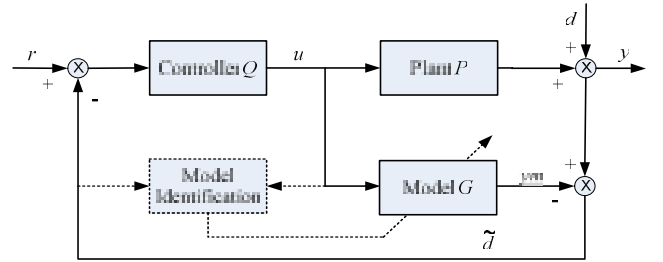

Fig. 1. IMC Principle

An IMC principle can be figured out in fig.1 without dotted line. The input reference  $r$  will be given as the reference input to controller  $Q$ . The controller will respond the input by sending any command  $u$  to the plant  $P$  and as the same time it is fed to the internal/efferent model  $G$ . The plant then moves to the desired output  $y$ . In case disturbance(s)  $d$  happen, the signal correction  $\tilde{d}$  as result of the desired output of both plant and efferent model will be fed back to the controller. Control law applied for the IMC control can be written as follows [12].

$$y = PQr + (1-GQ)d \quad (11)$$

$$u = Qr - Qd \quad (12)$$

$$e = (1-PQ)r - (1-GQ)d \quad (13)$$

The difference between classical controller and an IMC is that an IMC will correct the actual output before it is fed back. Since an IMC uses the efferent model, the model should be a perfect model to have the highest control performance. The way to provide the model in an IMC can be in forward model, inverse models, combination of both forward and inverse models, or adaptive model.

### C. Adaptive IMC Control

An adaptive IMC controller refers to a model and/or controller that can be updated in a certain time. By tuning a proper gain to the model and/or controller following the disturbance, the controller can be adaptive to the disturbance.

Figure 1 shows the diagram of an IMC with adaptive model as indicated with dotted line. In this case, the efferent model has been adapted using data identification.

### IV. POWER SYSTEM MODEL

Power system model is described using a differential algebraic equation (DAE) as [2],[7]:

$$\dot{x} = f(x, q, u, w) \quad (14)$$

$$0 = g(x, q, u, w) \quad (15)$$

Where  $x$ ,  $q$ ,  $u$  and  $w$  are the dynamic system states, the algebraic system states, the controller inputs and the system disturbance respectively. The algebraic states are not appeared in DAE so that it can be removed from the (14) and (15). The (14) is called differential variable and (15) is an algebraic equation or well known as a constraint.

Power system dynamics which include tie line power change can be redrawn in Fig. 3 [1],[6]-[8].

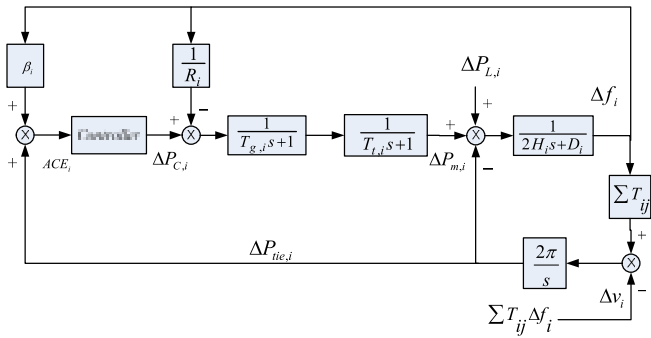

Fig. 2. Power system dynamics

The tie-line power change  $P_{tie}$  is calculated for all area  $n$  using (16) and the area control error (ACE) which is a suitable linear combination of frequency  $f$  and tie-line power changes for each area is found using (17) as follows[1],[7].

$$\Delta P_{tie,i} = \frac{2\pi}{s} \left[ \sum_{j=1, j \neq i}^n T_{ij} \Delta f_i - \sum_{j=1, j \neq i}^n T_{ij} \Delta f_j \right] \quad (16)$$

$$ACE_i = \Delta P_{tie,i} + \beta_i \Delta f_i \quad (17)$$

State space model for Fig. 2 is described in following equation.

$$\dot{x}(t) = Ax(t) + Bu(t) + Fw(t) \quad (18)$$

$$y(t) = Cx(t) + Du(t) \quad (19)$$

where

$$x(t) = \text{State variables} = [\Delta P_{g,i}, \Delta P_{m,i}, \Delta f_i, \Delta P_{tie,i}]^T$$

$$u(t) = \text{Input variables} = [\Delta P_{L,i}, \Delta v_i]^T$$

$$w(t) = \text{Control variable} = \Delta P_{c,i}$$

$$y(t) = \text{Output variable} = ACE_i$$

The feed forward matrix of the can be removed from the system matrices model since there is no direct connection between input and output variable. Therefore all of the matrices of the system model can be written in (20)-(23) [1],[7].

$$A = \begin{bmatrix} -\frac{1}{T_{g,i}} & 0 & -\frac{1}{R_i T_{g,i}} & 0 \\ \frac{1}{T_{t,i}} & -\frac{1}{T_{t,i}} & 0 & 0 \\ 0 & \frac{1}{2H_i} & -\frac{D_i}{2H_i} & -\frac{1}{2H_i} \\ 0 & 0 & 2\pi \sum_{j=1, j \neq i}^N T_{ij} & 0 \end{bmatrix} \quad (20)$$

$$B = \begin{bmatrix} \frac{1}{T_{g,i}} & 0 & 0 & 0 \end{bmatrix}^T \quad (21)$$

$$C = \begin{bmatrix} 0 & 0 & \beta_i & 1 \end{bmatrix} \quad (22)$$

$$F = \begin{bmatrix} 0 & 0 \\ 0 & 0 \\ -\frac{1}{2H_i} & 0 \\ 0 & -2\pi \end{bmatrix} \quad (23)$$

Where  $P_{g,i}$  is the governor output,  $P_{m,i}$  the mechanical power,  $P_{L,i}$  is the load/disturbance,  $P_{c,i}$  is the control action,  $y_i$  is the system output,  $H_i$  is the equivalent inertia constant,  $d_i$  is the equivalent damping coefficient,  $R_i$  is the speed droop characteristic and  $\beta_i$  is the a frequency bias factor of area  $i$ .  $T_{ij}$  is the tie-line synchronizing coefficient with area  $j$ ,  $T_{g,i}$  and  $T_{t,i}$  are the governor and turbine time constants of area  $i$ .

### V. SIMULATIONS

A three area power system is chosen to test the effectiveness of the proposed controller. The decision is based on variables needs and also time consuming for the simulation. Therefore this simulation can be extended to a larger area power system under consequence for the long simulation time. The configuration of investigated multi-area power system is depicted in Fig. 3.



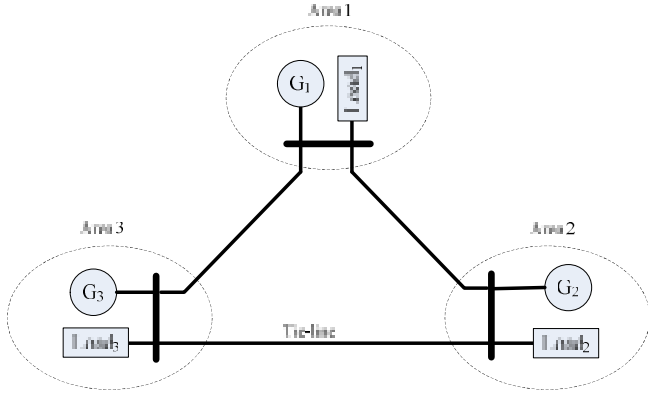

Fig. 3. Multi area power system configuration

TABLE I. PARAMETERS OF THE THREE AREA POWER SYSTEM

Area	$D$ [pu/Hz]	$2H$ [pu s]	$R$ [Hz/pu]	$T_g$ [s]	$T_i$ [s]	$\beta$ [pu/Hz]	$T_{ij}$ [pu/Hz]
1	0.015	0.1667	3.00	0.08	0.40	0.3483	$T_{12}=0.20$ $T_{13}=0.25$
2	0.016	0.2017	2.73	0.06	0.44	0.3827	$T_{21}=0.20$ $T_{23}=0.12$
3	0.015	0.1247	2.82	0.07	0.30	0.3692	$T_{31}=0.25$ $T_{32}=0.12$

The power system configuration is based on [5] and [6] with its parameter as shown in table I while the system dynamics are figured in fig. 2. Simulations were done in three cases which are with step disturbance and some noises, without disturbance and very high noises, and with mismatch model in point A-C as follows.

#### A. Case I: Step Disturbance

Nonlinear discrete type of MPC controller is built to control the power system frequency and the Laguerre function is chosen to build the MPC model. The scaling factor  $a$  and network lengths  $N$  for the model are same for each area about 0.3 and 4.

The step about 0.2 pu and disturbances with maximum 0.1 pu of the generator capacity are applied to area 1 to 3. Therefore the measured properties of the response are given in table IV while the simulation result is shown in fig. 4.

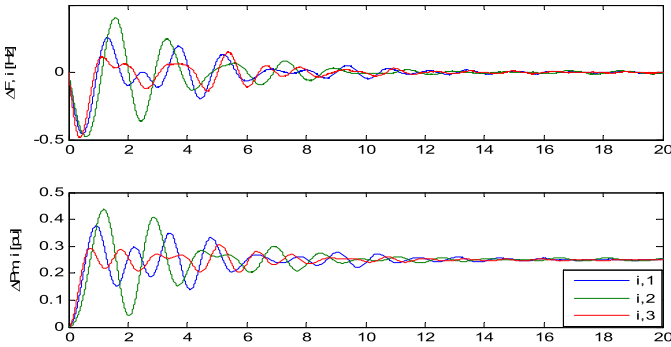

Fig. 4. MPC controller responses in case I

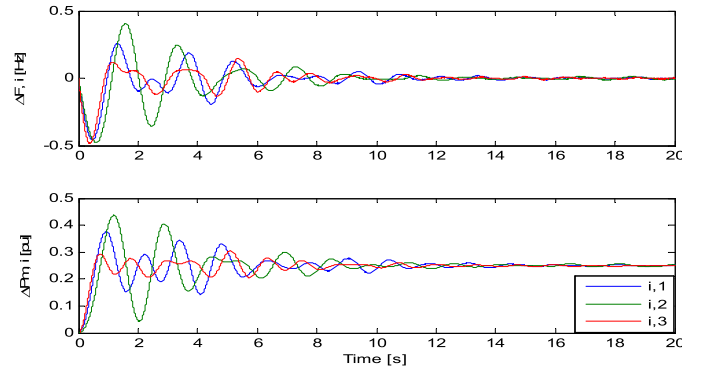

Fig. 5. Adaptive IMC-MPC controller responses in case I

An adaptive IMC-MPC scheme has been built to be applied to the system. In this case the model will be updated each second with the input output data. The data is then used to build the adaptive model. With the same treatment as in MPC controller, the adaptive IMC-MPC simulation result is shown in fig. 5.

#### B. Case II: Very High Noises

The MPC and IMC-MPC are then used in another case with very noisy. In this case I, the step disturbance is set to zero and a random about maximum 0.5 pu of the generator capacity is applied to all areas. Responses of the both controller are then figured in fig. 6 for MPC and fig. 7 for IMC-MPC.

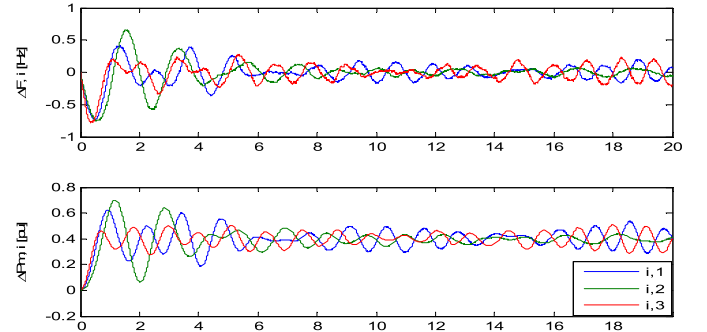

Fig. 6. MPC controller responses in case II

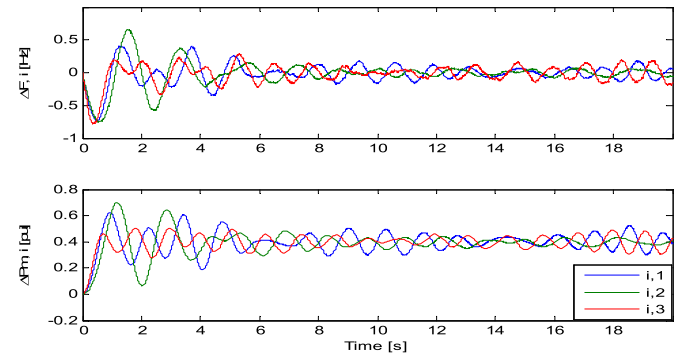

Fig. 7. Adaptive IMC-MPC controller responses in case II

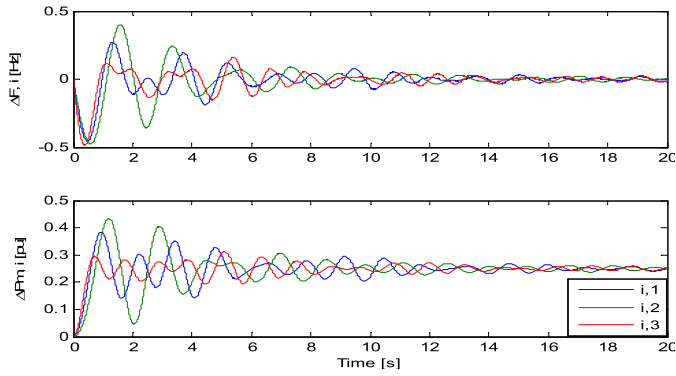

Fig. 8. MPC controller responses in case III

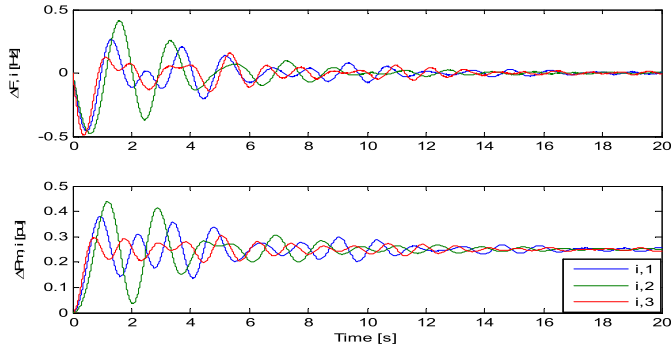

Fig. 9. Adaptive IMC-MPC controller responses in case III

### C. Case III: Mismatch Model

In this case, a mismatch model is applied to all areas in term of governor time constant. The time constant is change for each area generator by increasing (area 1 and 3) and decreasing (area 2) its values by 0.01s. After the changes, the system is then tested with a 0.2 pu. step disturbance for all areas. Result for the system responses is figured in fig. 8 and 9 for MPC and IMC-MPC respectively.

### D. Performance Evaluation

Base on system response in fig.4 to 9, the overshoot decay ratio and standard deviation are analyzed and the result is provided in Table II and Table III. For case I and II, IMC-MPC controller gives very good response in area 1 and 3. On the other hand IMC-MPC controller is superior in all area of case III. On the other hand IMC-MPC controller has high decay ratio in most area and cases which indicate that this controller can slowly reduce the frequency deviation.

TABLE II. FREQUENCY DEVIATION ANALYSIS

	Area	MPC			IMC-MPC		
		case I	case II	case III	case I	case II	case III
Overshoot	1	0.2582	0.4128	0.2738	0.2574	0.4115	0.2737
	2	0.4049	0.6605	0.4025	0.4049	0.6608	0.4024
	3	0.1191	0.2037	0.1643	0.1181	0.2026	0.1614
Decay Ratio	1	0.7378	0.9617	0.7213	0.7570	0.9779	0.7850
	2	0.6090	0.5687	0.6104	0.6153	0.5687	0.6192
	3	0.3168	0.8391	0.4802	0.3391	0.6935	0.3995
Standard Deviation	1	0.0916	0.1673	0.0943	0.0921	0.1665	0.0938
	2	0.1233	0.1976	0.1229	0.1234	0.1975	0.1223
	3	0.0808	0.1581	0.0847	0.0809	0.1532	0.0844

TABLE III. PRIME MOVER DEVIATION ANALYSIS

	Area	MPC			IMC-MPC		
		case I	case II	case III	case I	case II	case III
Overshoot	1	0.1465	0.2354	0.1464	0.1441	0.2321	0.1004
	2	0.1729	0.2713	0.1718	0.1719	0.2709	0.1209
	3	0.1652	0.2649	0.1661	0.1612	0.2597	0.1195
Decay Ratio	1	0.9156	0.9633	0.9142	0.9254	0.9722	0.9406
	2	0.8937	0.8728	0.9081	0.8940	0.8712	0.9077
	3	0.9149	0.9239	0.9386	0.9164	0.9746	0.9240
Standard Deviation	1	0.0294	0.0531	0.1464	0.0318	0.0504	0.2738
	2	0.0443	0.0710	0.1718	0.0466	0.0691	0.4024
	3	0.0278	0.0534	0.1661	0.0700	0.0500	0.1614

About prime mover deviation, IMC-MPC controller has perfect overshoot in all areas and all cases comparing to the MPC controller. It is also shown that IMC-MPC controller is more dynamic than MPC controller as it has high standard deviation and decay ratio values.

## VI. CONCLUSION

This paper has introduced a new combination of an adaptive IMC-MPC controller and based on the authors' knowledge, this controller is recognized as a new type of IMC controller. The controller has been validated in handling load frequency control of a three area power system. Result of simulation shows that the IMC-MPC controller provides good response in most system response, especially in the case of mismatch model where the adaptive IMC-MPC controller demonstrates its superiority.

## ACKNOWLEDGMENT

The first author would like to thanks for University of Papua as well as Indonesian Ministry of Research, Technology and Higher Education Directorate via General of Higher Education that support his study and research in Hiroshima University. An acknowledgement is also addressed to Edwin Tazelaar, PhD for his special advises.

## REFERENCES

- [1] T.H. Mohamed, J. Morel, H. Bevrani, and T. Hiyama, "Model predictive based load frequency control design concerning wind turbines," *Electrical Power and Energy Systems*, Vol. 43, pp. 859-867, July 2012.
- [2] A. M. Ersdal, Imsland, K. Uhlen, "Model Predictive Load-Frequency Control," *IEEE Trans. on Power Syst.* Vol.31, No.1, pp.777-785, 2016.
- [3] S.K. Jain, A. Bhargava, and R.K. Pal, "Three area power system load frequency control using fuzzy logic controller," *International Conference on Computer, Communication and Control*, Sept. 2015.
- [4] L. Cai, Z. He and H. Hu, "A New Load Frequency Control Method of Multi-Area Power System via the Viewpoints of Port-Hamiltonian System and Cascade System," in *IEEE Transactions on Power Systems*, vol. 32, no. 3, pp. 1689-1700, May 2017.
- [5] L. Wang, "Model Predictive Control System Design and Implementation Using MATLAB," Springer-Verlag, London, 2009.
- [6] H. Bevrani, "Robust Power System Frequency Control," New York: Springer, 2009.
- [7] A. B. Rehiara, Y. Sasaki, N. Yorino and Y. Zoka, "A Performance Evaluation of Load Frequency Controller using Discrete Model Predictive Controller," 2016 International Seminar on Intelligent Technology and Its Applications (ISITIA), Lombok, 2016, pp. 655-660.
- [8] V. Kumtepel, Y. Wang and A. Tripathi, "Multi-area model predictive load frequency control: A decentralized approach," 2016 Asian Conference on Energy, Power and Transportation Electrification (ACEPT), Singapore, 2016, pp. 1-5.

- [9] L. Fan and X. Wang, "Internal Model Based Iterative Learning Control for Linear Motor Motion Systems," Sixth International Conference on Intelligent Systems Design and Applications, Jinan, 2006, pp. 62-66.
- [10] K. Watanabe and E. Muramatsu, "Adaptive internal model control of SISO systems," SICE 2003 Annual Conference (IEEE Cat. No.03TH8734), Fukui, Japan, 2003, pp. 3084-3089 Vol.3.
- [11] Z. Qiu, M. Santillo, J. Sun and M. Jankovic, "Enhanced composite adaptive IMC for boost pressure control of a turbocharged gasoline engine," 2016 American Control Conference (ACC), Boston, MA, 2016, pp. 3286-3291.
- [12] T. Shigemasa, M. Yukitomo and R. Kuwata, "A model-driven PID control system and its case studies," Proceedings of the International Conference on Control Applications, 2002, pp. 571-576 vol.1.
- [13] H. Seki, "Adaptive IMC-PI controllers for process applications," 2016 12th IEEE International Conference on Control and Automation (ICCA), Kathmandu, 2016, pp. 455-460.
- [14] Jun-Jie Gu, Li Shen and Luan-Ying Zhang, "Application of Internal Model and Self-Adaptive PSD Controller in the Main Steam Temperature System," 2005 International Conference on Machine Learning and Cybernetics, Guangzhou, China, 2005, pp. 570-573.
- [15] Y. Baba, T. Shigemasa, M. Yukitomo, F. Kojima, M. Takahashi and E. Sasamura, "Model-driven PID control system in single-loop controller," SICE 2003 Annual Conference (IEEE Cat. No.03TH8734), Fukui, Japan, 2003, pp. 187-190 Vol.1.
- [16] M. Shamsuzzoha and M. Lee, "IMC Based Control System Design of PID Cascaded Filter," 2006 SICE-ICASE International Joint Conference, Busan, 2006, pp. 2485-2490.
- [17] W. K. Ho, T. H. Lee, H. P. Han and Y. Hong, "Self-tuning IMC-PID control with interval gain and phase margins assignment," in IEEE Trans. on Control Systems Technology, vol. 9, no.3, pp. 535-541, 2001.
- [18] Q. b. Jin, C. l. Feng and M. x. Liu, "Fuzzy IMC for Unstable Systems with Time Delay," 2008 IEEE Pacific-Asia Workshop on Computational Intelligence and Industrial Application, Wuhan, 2008, pp. 772-778.
- [19] W. F. Xie and A. B. Rad, "Fuzzy adaptive internal model control," 1998 IEEE International Conference on Fuzzy Systems Proceedings. IEEE World Congress on Computational Intelligence (Cat. No.98CH36228), Anchorage, AK, 1998, pp. 516-521 vol.1.
- [20] D. C. Psychogios and L. H. Ungar, "Nonlinear internal model control and model predictive control using neural networks," Proceedings. 5th IEEE International Symposium on Intelligent Control 1990, Philadelphia, PA, 1990, pp. 1082-1087.
- [21] Li Yan, A. B. Rad, Y. K. Wong and H. S. Chan, "Model based control using artificial neural networks," Proceedings of the 1996 IEEE International Symposium on Intelligent Control, Dearborn, MI, 1996, pp. 283-288.
- [22] A. Miliadis-Argeitis and M. Khammash, "Adaptive Model Predictive Control of an optogenetic system," 2015 54th IEEE Conference on Decision and Control (CDC), Osaka, 2015, pp. 1265-1270.
- [23] Lennart Ljung, *System Identification: Theory for the User*, Second Edition, Prentice Hall PTR, 1999.