

## DATA ARTIKEL ILMIAH

Judul	: Optimal selection of LQR parameter using AIS for LFC in a multi-area power system
Penulis	: Muhammad Abdillah, Herlambang Setiadi, Adelhard Beni Rehiara, Karar Mahmoud, Imam Wahyudi Farid, Adi Soeprijanto
Abstrak	: This paper proposes a method to optimize the parameter of the linear quadratic regulator (LQR) using artificial immune system (AIS) via clonal selection. The parameters of LQR utilized in this paper are the weighting matrices Q and R. The optimal LQR control for load frequency control (LFC) is installed on each area as a decentralized control scheme. The aim of this control design is to improve the dynamic performance of LFC automatically when unexpected load change occurred on power system network. The change of load demands 0.01 p.u used as a disturbance is applied to LFC in Area 1. The proposed method guarantees the stability of the overall closed-loop system. The simulation result shows that the proposed method can reduce the overshoot of the system and compress the time response to steady-state which is better compared to trial error method (TEM) and without optimal LQR control.
Keywords	: linear quadratic regulator (LQR); artificial immune system; clonal selection; load frequency control (LFC)
Nama Jurnal	: Journal of Mechatronics, Electrical Power, and Vehicular Technology
Volume/Nomor	: Volume 7, No 2
Edisi	: 2016
Alamat web	: <a href="http://www.mevjournal.com/index.php/mev/article/view/301/optimal-selection-of-lqr-parameter-using-ais-for-lfc-in-a-multi-area-power-system">http://www.mevjournal.com/index.php/mev/article/view/301/optimal-selection-of-lqr-parameter-using-ais-for-lfc-in-a-multi-area-power-system</a>
Kategori	: Jurnal Nasional Terakreditasi (Sinta 2)
SJR	: -

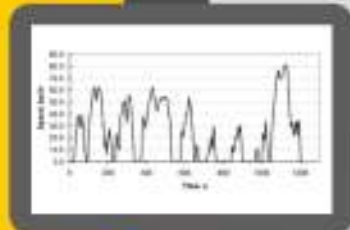
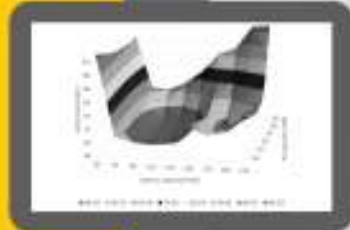

**Derivative Load Voltage and Particle Swarm Optimization to Determine Optimum Sizing and Placement of Shunt Capacitor in Improving Line Losses**  
M.M. Baiek, A.E. Esmail, M. Nizam, M. Anwar, H.M.S. Atia

**Simple Supercapacitor Charging Scheme of an Electric Vehicle on Small-Scale Hardware Simulator: A Prototype Development for Education Purpose**  
A.R. Al Tahtawi, A.S. Rohman

**Fuel Consumption and CO2 Emission Investigation of Range Extender With Diesel and Gasoline Engine**  
B. Wahono, A. Nur, A. Praptijanto, W.B. Santoso, Suherman, Z. Lu

**Optimal Selection of LQR Parameter Using AIS for LFC in a Multi-Area Power System**  
M. Abdillah, H. Setiadi, A.B. Reihana, K. Mahmoud, I.W. Farid, A. Soeprijanto

**Accuracy Analysis of Geometrical and Numerical Approaches for Two Degrees of Freedom Robot Manipulator**  
H.M. Saputra, M. Mirdanias, E. Rijanto

**A Hybrid PV-Battery/Diesel Electricity Supply on Peucang Island: An Economic Evaluation**  
M. Günther

Published by:  
Research Centre for Electrical Power and Mechatronics  
Indonesian Institute of Sciences 

# Journal of Mechatronics, Electrical Power, and Vehicular Technology

Volume 07, Issue 2, December 2016

## EDITOR-IN-CHIEF

**Prof. Dr. Estiko Rijanto**  
Indonesian Institute of Sciences  
(LIPI), Komp LIPI Jl Sangkuriang,  
Blg 20, 2<sup>nd</sup> Fl, Bandung 40135,  
Indonesia  
estiko.rijanto@lipi.go.id

## INTERNATIONAL EDITORIAL BOARD

**Prof. Rosli bin Abu Bakar**  
Faculty of Mechanical  
Engineering, Universiti Malaysia  
Pahang  
26600 Pekan, Pahang, Malaysia

**Prof. Ir. Jamasri, Ph.D.**  
Department of Mechanical and  
Industrial Engineering, Gadjah  
Mada University  
Jl. Grafika  
No. 2, Yogyakarta, 55281,  
Indonesia

**Prof. Tapan Kumar Saha**  
Electrical Engineering,  
The University of Queensland  
St. Lucia, Qld-4072, Australia

**Prof. Muhammad Nizam, S.T,  
M.T, Ph.D.**  
Department of Mechanical  
Engineering, Universitas Sebelas  
Maret Surakarta  
Jl. Ir. Sutami 36 A, Surakarta,  
57126, Indonesia

**Prof. Taufik**  
Director of Electric Power  
Institute, California Polytechnique  
San Luis Obispo, CA 93407,  
United States

**Prof. Dr. Tagawa Yasutaka**  
Tokyo University of Agriculture  
and Technology  
Naka-machi 2 - 24 - 16, Koganei  
- shi, Tokyo, 184 - 8588, Japan

**Prof. Dr. Bambang Riyanto**  
School of Electrical Engineering  
and Informatics, Bandung  
Institute of Technology  
Jl. Ganesha No. 10, Bandung  
40135, Indonesia

**Prof. Dr. Ir. R. Danardono Agus  
Sumarsono, DEA, PE**  
Department of Mechanical  
Engineering, University of  
Indonesia  
Kampus UI Depok 16424  
Depok, Jawa Barat, Indonesia

**Prof. Dr. Adi Soeprijanto**  
Department of Electrical  
Engineering, Faculty of Industrial  
Technology, Institut Teknologi  
Sepuluh Nopember (ITS)  
Campus ITS Keputih, Surabaya  
60111, Indonesia

**Prof. Keum Shik Hong**  
Department of Mechanical  
Engineering,  
Pusan National University, Korea,  
Republic of

**Prof. Josep M Rossell**  
Control, Dynamics and  
Applications (CoDALab),  
Department of Mathematics  
Universitat Politècnica de  
Catalunya (UPC), Avda. Bases de  
Manresa, 61-73 08242 - Manresa  
(Barcelona), Spain

**Assoc. Prof. John Young**  
School of Engineering and IT,  
The University of New South  
Wales, Australian Defence Force  
Academy, PO Box 7916,  
Canberra BC ACT 2610,  
Australia

**Dr. Tatacipta Dirgantara**  
Mechanical and Aerospace  
Engineering, Bandung Institute of  
Technology, Jl. Ganesha No. 10,  
Bandung 40135, Indonesia

**George Anwar, Ph.D.**  
University of California,  
101 Sproul Hall, Berkeley, CA  
94704, United States

**Dr. Agus Sunjarianto Pamitran**  
Department of Mechanical  
Engineering, University of  
Indonesia  
Kampus UI Depok 16424  
Depok, Jawa Barat, Indonesia

**Dr. Jose Guivant**  
School of Mechanical and  
Manufacturing Engineering, The  
University of New South Wales  
Ainsworth Building (J17)  
Level 3, Room 311B, Kensington  
Campus, Australia

**Dr. Ir. Pekik Argo Dahono**  
School of Electrical Engineering  
and Informatics, Bandung  
Institute of Technology  
Jl. Ganesha No. 10, Bandung  
40135, Indonesia

**Riza Muhida, Ph.D.**  
STKIP Surya  
Jl. Scientia Boulevard Blok U/7  
Summarecon Gading Serpong,  
Tangerang, Banten, 15810,  
Indonesia

**Dr. Larissa Lorenz**  
Bauhaus Luftfahrt e.V.,  
Lyonel-Feiningger-Str. 28, 80807  
Munich, Germany

**Dr. Arjon Turnip**  
Technical Management Unit for  
Instrumentation Development -  
LIPI  
Komp LIPI Jl Sangkuriang, Bld  
40, Bandung 40135, Indonesia

**Dr.Eng. Budi Prawara**  
Research Centre for Electrical  
Power and Mechatronics – LIPI  
Komp LIPI Bandung, Blg 20, 2<sup>nd</sup>  
Fl, Bandung 40135, Indonesia

# Journal of Mechatronics, Electrical Power, and Vehicular Technology

Volume 07, Issue 2, December 2016

## ADVISORY EDITOR

**Dr. Endra Joelianto**  
Engineering Physics,  
Bandung Institute of Technology  
Jl. Ganesha No. 10, Bandung  
40135, Indonesia

## DEPUTY EDITORS

**Aam Muharam, M.T.**  
Dept. of Applied Science for  
Electronics and Materials. Kyushu  
University  
6-1 Kasuga-koen, Kasuga-City,  
Fukuoka – Japan

**Tinton D Atmaja, M.T.**  
Research Centre for Electrical  
Power and Mechatronics – LIPI  
Komp LIPI Bandung, Blg 20, 2<sup>nd</sup>  
Fl, Bandung 40135, Indonesia

## MANAGING EDITORS, CENTRAL OFFICE

**Ghalya Pikra, M.T.**  
Research Centre for Electrical  
Power and Mechatronics – LIPI  
Komp LIPI Bandung, Blg 20, 2<sup>nd</sup>  
Fl, Bandung 40135, Indonesia  
Mechanical Engineering

**Merry I Devi, S.T.**  
Research Centre for Electrical  
Power and Mechatronics – LIPI  
Komp LIPI Bandung, Blg 20, 2<sup>nd</sup>  
Fl, Bandung 40135, Indonesia  
Industrial Engineering

**Hendri M Saputra, M.T.**  
Research Centre for Electrical  
Power and Mechatronics – LIPI  
Komp LIPI Bandung, Blg 20, 2<sup>nd</sup>  
Fl, Bandung 40135, Indonesia  
Robotics and Mechatronics

## MANAGING EDITOR, ASIA PACIFIC REGION

**Yanuandri Putrasari, M.Eng.**  
Ulsan University  
93 Daehak-ro, Mugeo-dong,  
Nam-gu, Ulsan, South Korea,  
Republic of

## MANAGING EDITOR, EUROPE REGION

**Naili Huda, M.Eng.Sc.**  
Warwick University  
Coventry CV4 7AL, United  
Kingdom

## EDITORS

**Aditya Sukma Nugraha, M.T.**  
Mechanical Engineering

**Agus Risdiyanto, M.T.**  
Electrical Engineering

**Amin, M.T.**  
Electrical Engineering

**Arief A Firdaus, S.I.Kom.**  
Communication Science

**Arini Wresta, M.Eng.**  
Chemical Engineering

**Bambang Wahono, M.Eng.**  
Mechanical Engineering

**Dian Andriani, M.Eng.**  
Bioenergy Engineering

**Dr. Edwar Yazid**  
Dynamics and Control System

**Kadek Heri Sanjaya, Ph.D**  
Ergonomics, Biomechanics,  
Physiology

**Maulana Arifin, M.T.**  
Mechanical Engineering

**Midriem Mirdanies, M.T.**  
Computer Engineering

**Muhammad Kasim, M.Eng**  
Electrical Engineering

**Nur Rohmah, M.T.**  
Chemical Engineering

**Rakhmad Indra Pramana, M.T.**  
Mechanical and Material  
Engineering

**Rifa Rahmayanti, M.Sc**  
Mechatronics and Robotics

**Sapdo Utomo, M.T.**  
Mechatronics and Robotics

**Vita Susanti, S.Kom**  
Computer Science

**Yayat Ruhiyat, A.Md.**  
Electrical Engineering

## WEB ADMIN

**Dadan R Saleh, M.T.**  
Informatics Engineering

## SECRETARIAT

**Andri J Purwanto, S.T.**  
Mechanical Engineering

## GRAPHIC DESIGNER

**Yukhi Mustaqim Kusuma Sya  
Bana, S.Sn.**  
Graphic Design

# Journal of Mechatronics, Electrical Power, and Vehicular Technology

Volume 07, Issue 2, December 2016

## LIST OF CONTENTS

Derivative load voltage and particle swarm optimization to determine optimum sizing and placement of shunt capacitor in improving line losses <i>Mohamed Milad Baiek, Ahmad E. Esmaio, Muhammad Nizam, Miftahul Anwar, Hasan M.S. Atia</i> .....	67-76
Simple supercapacitor charging scheme of an electric vehicle on small-scale hardware simulator: a prototype development for education purpose <i>Adnan Rafi Al Tahtawi, Arief Syaichu Rohman</i> .....	77-86
Fuel consumption and CO <sub>2</sub> emission investigation of range extender with diesel and gasoline engine <i>Bambang Wahono, Arifin Nur, Achmad Praptijanto, Widodo Budi Santoso, Suherman, Zong Lu</i> .....	87-92
Optimal selection of LQR parameter using AIS for LFC in a multi-area power system <i>Muhammad Abdillah, Herlambang Setiadi, Adelhard Beni Reihara, Karar Mahmoud, Imam Wahyudi Farid, Adi Soeprijanto</i> .....	93-104
Accuracy analysis of geometrical and numerical approaches for two degrees of freedom robot manipulator <i>Hendri Maja Saputra, Midriem Mirdanies, Estiko Rijanto</i> .....	105-112
A hybrid PV-battery/diesel electricity supply on Peucang island: an economic evaluation <i>Matthias Günther</i> .....	113-122



## OPTIMAL SELECTION OF LQR PARAMETER USING AIS FOR LFC IN A MULTI-AREA POWER SYSTEM

Muhammad Abdillah <sup>a,\*</sup>, Herlambang Setiadi <sup>b</sup>, Adelhard Beni Reihara <sup>a, c</sup>,  
Karar Mahmoud <sup>d</sup>, Imam Wahyudi Farid <sup>a</sup>, Adi Soeprijanto <sup>e</sup>

<sup>a</sup> Department of Cybernetics, Graduate School of Engineering, Hiroshima University  
4-1, Kagamiyama 1chome, Higashi-Hiroshima, 739-8527, Japan

<sup>b</sup> Department of Electrical Engineering, University of Bhayangkara  
Jl. Ahmad Yani 114, Surabaya, East Java 60231, Indonesia

<sup>c</sup> Department of Electrical Engineering, University of Papua  
Jln. Gunung Salju, Amban, Manokwari, Indonesia

<sup>d</sup> Faculty of Engineering, Aswan University

Sahari city-Airport Way, Aswan, 81528, Egypt

<sup>e</sup> Department of Electrical Engineering, Institut Teknologi Sepuluh Nopember,  
Building B, C & AJ Campus ITS Sukolilo Surabaya, East Java 60111, Indonesia

Received 30 March 2016; received in revised form 01 October 2016; accepted 03 October 2016

Published online 23 December 2016

### Abstract

This paper proposes a method to optimize the parameter of the linear quadratic regulator (LQR) using artificial immune system (AIS) via clonal selection. The parameters of LQR utilized in this paper are the weighting matrices Q and R. The optimal LQR control for load frequency control (LFC) is installed on each area as a decentralized control scheme. The aim of this control design is to improve the dynamic performance of LFC automatically when unexpected load change occurred on power system network. The change of load demands 0.01 p.u used as a disturbance is applied to LFC in Area 1. The proposed method guarantees the stability of the overall closed-loop system. The simulation result shows that the proposed method can reduce the overshoot of the system and compress the time response to steady-state which is better compared to trial error method (TEM) and without optimal LQR control.

Keywords: linear quadratic regulator (LQR); artificial immune system; clonal selection; load frequency control (LFC)

### I. INTRODUCTION

Load frequency control (LFC) is one of the main parts of the power system where the main function of LFC is to maintain the frequency fluctuation during exchange power in the power system network on which the generator dispatch must satisfy the system conditions caused by the fluctuation of load change [1].

Multi-area power system is a complex dynamic system. The decentralized control design is suitable for multi-area power system because the controller is set to work in each area. The controller works based on the information

only on each area. When any change of output variables in one area occurs, only the controller takes action in order to maintain the stability from a disturbance in its area. The improvement of the dynamic performance caused by small load change has been reported by Robandy *et al.* [2] and the application of optimal control to improve the dynamic performance on power system using a linear quadratic regulator (LQR) is provided by Mahmud *et al.* [3]. The method used to improve the dynamic performance on power system by those two previous researches [2, 3] provides satisfactory results. The number of control strategies has been employed in control design of LFC in order to achieve better dynamic performance [4-6].

\* Corresponding Author. Tel: +81-8042671315  
E-mail: abdee.muhammad83@gmail.com

Many types of artificial immune system (AIS) algorithms are based on the variety of immunological studies such as immune network [7], negative selection [8], danger theory [9], and clonal selection [10]. Clonal selection algorithm (CSA) is a special type of AIS which uses the clonal selection part of the AIS as the main mechanism. Clonal selection is based on a situation of 'B' cell response against nonself-molecule called antigen with an affinity by proliferating and producing antibody in order to kill antigenic cells [11]. AIS via clonal selection is one of metaheuristic methods utilized to solve a complex problem in optimization research field. The optimal solution obtained by AIS via clonal selection is better than optimal solution produced by a genetic algorithm (GA) [12]. Furthermore, the AIS via clonal selection is more efficient than other classical heuristic algorithms such as simulated annealing (SA), tabu search (TB), and GA [13].

AIS via clonal selection had received much attention regarding its potential as a global optimization technique and it has been applied in power system research field as reported in [14-16]. In research by Li *et al.* [14], AIS via clonal was used for allocating an optimal var compensator in power system. AIS via clonal selection was used to adjust the parameter of PSS based LQR in the single machine infinite bus (SMIB) by Haybar *et al.* [15]. The authors apply optimal LQR control as PSS to a study dynamic stability. Maryono *et al.* [16] uses AIS via clonal selection for tuning parameter of the thyristor controlled series capacitor (TCSC) and PSS for damping controller in power system.

This paper proposes AIS via clonal selection to tune Q and R matrices as to obtain feedback controller gain where applied for multi-area load frequency control (LFC). Some of the classical control approaches for LFC are based on mathematical models. These approaches have difficulties in gaining the control purposes in the presence of changing the operating points such as load changes under which the model is derived, and lack of system components. In order to tackle these limitations, an application of intelligent technology is proposed. In this paper, AIS via clonal selection method is utilized to optimize the parameters of LQR. The weighting matrices Q and R of LQR are important parameters which obtaining an optimal feedback gain to improve the dynamic performance of LFC in multi-area power system by observing the change of frequency in each area. This paper is organized as follows: the power system model of LFC for multi-area power system is explicated in section

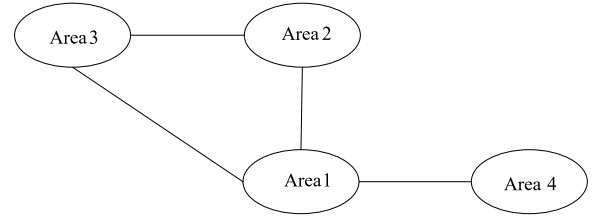

Figure 1. Multi-area power system configuration

II. The proposed method is introduced in section III. The implementation of proposed method is given in section IV. The simulation results are shown in section V.

## II. POWER SYSTEM MODEL

The configuration of a multi-area power system in this paper is depicted in Figure 1. It consists of 4 LFC areas where each area has a number of generators. All generators in one area are simplified as an equivalent generator unit (EGU).

In a certain LFC area the dynamical model of its EGU can be expressed as follows: without generator rates and/or turbine dead-band, the dynamic model can be expressed as a linear model in the following equations.

$$\Delta \dot{f}_i = \frac{K_{pi}}{T_{pi}} \Delta P_{mi} - \frac{K_{pi}}{T_{pi}} \Delta P_{tie-i} - \frac{1}{T_{pi}} \Delta f_i - \frac{K_{pi}}{T_{pi}} \Delta P_{Li} \quad (1)$$

$$\Delta \dot{P}_{Ti} = \frac{1}{T_{Ti}} \Delta P_{Gi} - \frac{1}{T_{Ti}} \Delta P_{Ti} \quad (2)$$

$$\Delta \dot{P}_{Gi} = \frac{1}{T_{Gi}} \Delta P_{ci} - \frac{1}{T_{Gi} R_i} \Delta f_i - \frac{1}{T_{Gi}} \Delta P_{Gi} + \frac{1}{T_{Gi}} u_i \quad (3)$$

$$\Delta \dot{P}_{ci} = -K_{li} B_i \Delta f_i - K_{li} \Delta P_{tie-i} \quad (4)$$

$$\Delta \bar{P}_{tie-i} = \frac{1}{S} (T_{ij} \Delta f_i - T_{ij} \Delta f_j) \quad (5)$$

The linear dynamic model of the  $i$ th LFC area is depicted in Figure 2. Equations (1)-(5) form a state-space model representation as follow [17]:

$$\dot{x}_i(t) = \mathbf{A}_i x_i(t) + \sum_{\substack{j=1 \\ j \neq i}}^N \mathbf{A}_{ij} x_j(t) + \mathbf{B}_i u_i(t) + \mathbf{F}_i \Delta P_{Li}(t) \quad (6)$$

$$y_i(t) = \mathbf{C}_i x_i(t) \quad (7)$$

where  $x_i(t) \in \mathcal{R}^n$  is state variable of area  $i$ ,  $u_i(t) \in \mathcal{R}^m$  is input variable of area  $i$ , and  $y_i(t) \in \mathcal{R}^r$  is output variable of area  $i$ . The variables are defined as follows:

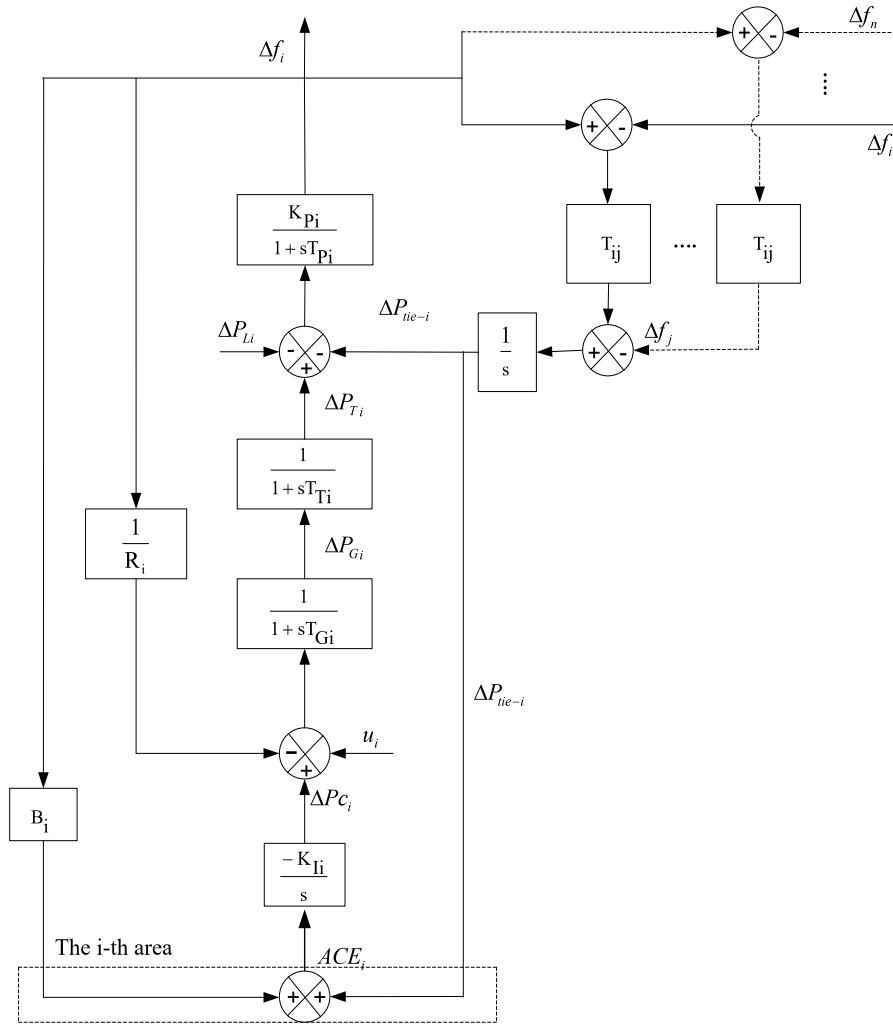

Figure 2. A linear block diagram of the *i*-th LFC area

$$x_i(t) = [\Delta f_i \Delta P_{Ti} \Delta P_{Gi} \Delta P_{Ci} \Delta P_{tie-i}]^T \quad (8)$$

$$u_i(t) = \text{the } i\text{-th area input signal of } ACE_i \quad (9)$$

$$ACE_i = \Delta P_{tie-i} + B_i \Delta f_i \quad (10)$$

$$y_i(t) = \Delta f_i \quad (11)$$

Definitions of model parameters and variables stated in equations (1)–(7) are shown in Table 1. By combining 4 EGUs, a block diagram of LFC in the four areas power systems can be illustrated in Figure 3. Its state space equation is described as follows:

$$\dot{x}_i(t) = A_i x_i(t) + \sum_{\substack{j=1 \\ j \neq i}}^N A_{ij} x_j(t) + B_i u_i(t) + F_i \Delta P_{L,i}(t) \quad (12)$$

$$y_i(t) = C x_i(t) \quad (13)$$

State variable, input variable and output are given by:

$$x(t) = [\Delta f_1 \Delta P_{T1} \Delta P_{G1} \Delta P_{C1} \Delta P_{tie-1} \Delta f_2 \Delta P_{T2} \Delta P_{G2} \Delta P_{C2} \Delta P_{tie-2} \Delta f_3 \Delta P_{T3} \Delta P_{G3} \Delta P_{C3} \Delta P_{tie-3} \Delta f_4 \Delta P_{T4} \Delta P_{G4} \Delta P_{C4} \Delta P_{tie-4}]^T \quad (14)$$

Table 1. Definitions of model parameters and variables

Parameter/ Variable	Descriptions
$\Delta f_i$	The <i>i</i> -th area frequency deviation
$\Delta P_{Ti}$	The <i>i</i> -th area turbine output deviation
$\Delta P_{Gi}$	The <i>i</i> -th area governor output deviation
$\Delta P_{Ci}$	The <i>i</i> -th area control input deviation
$\Delta P_{tie-i}$	The <i>i</i> -th area net tie-line power deviation
$\Delta P_{L-i}$	The <i>i</i> -th area load disturbance
$D_i$	The <i>i</i> -th area load damping coefficient
$M_i$	The <i>i</i> -th area inertia constant
$R_i$	The <i>i</i> -th area governor speed regulation
$T_{Ti}$	The <i>i</i> -th area turbine time constant
$T_{Gi}$	The <i>i</i> -th area governor time constant
$T_{ij}$	The <i>i</i> -th area synchronizing coefficient
$K_{ji}$	The <i>i</i> -th area integration gain
$B_i$	The <i>i</i> -th area frequency bias parameter
$K_{pi}$	The <i>i</i> -th area power system gain
$T_{pi}$	The <i>i</i> -th area power system time constant
$u_i$	The <i>i</i> -th area input signal



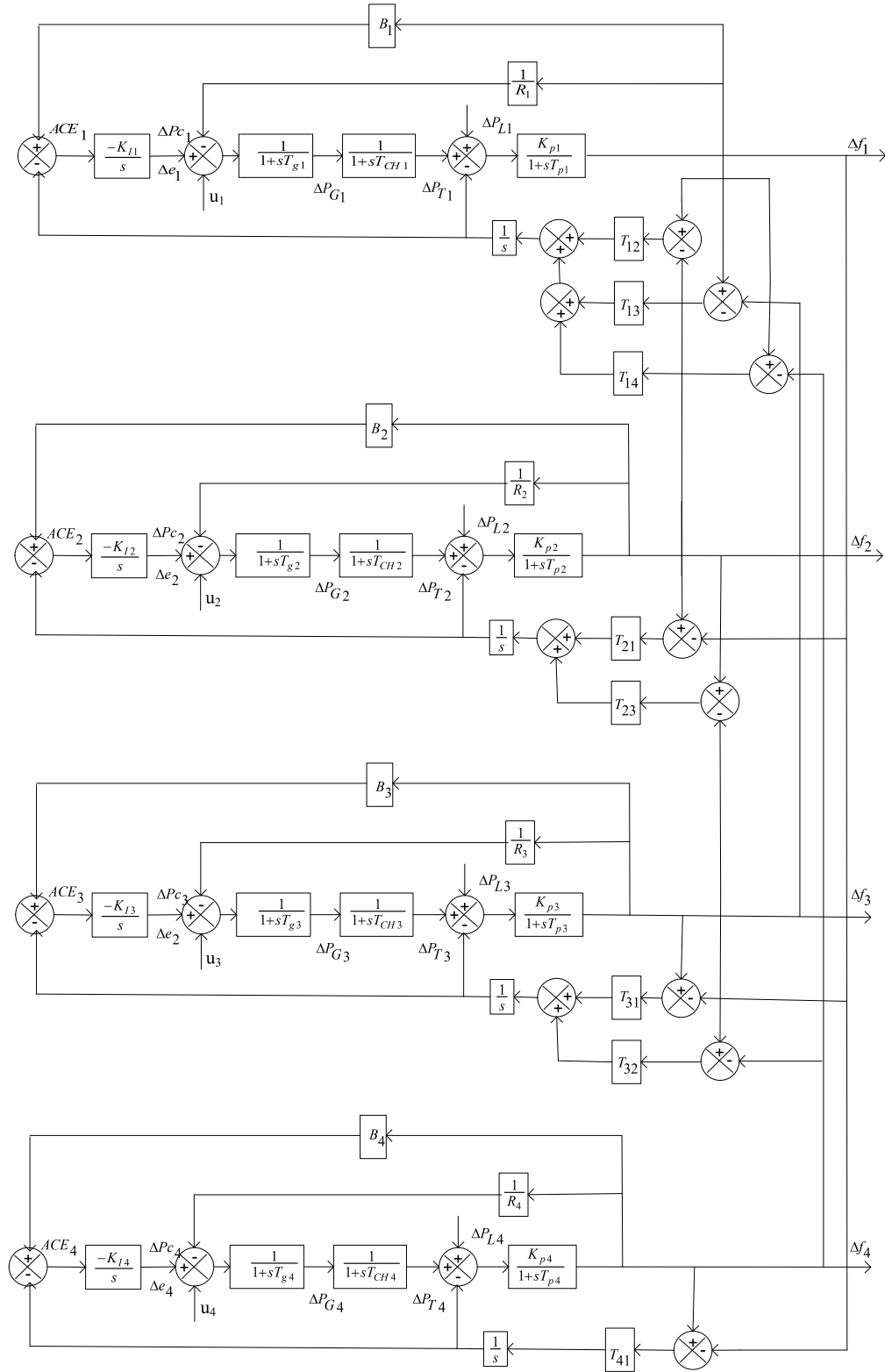

Figure 3. Block diagram of 4 areas LFC power system in linear model

$$u(t) = [u_1 \ u_2 \ u_3 \ u_4]^T \quad (15)$$

$$y(t) = [\Delta f_1 \ \Delta f_2 \ \Delta f_3 \ \Delta f_4]^T \quad (16)$$

where  $\Delta f_1, \Delta f_2, \Delta f_3, \Delta f_4$  are frequency deviation for area 1, 2, 3, and 4, respectively;  $\Delta P_{T1}, \Delta P_{T2}, \Delta P_{T3}, \Delta P_{T4}$  express of turbine output deviation for area 1, 2, 3, and 4;  $\Delta P_{G1}, \Delta P_{G2}, \Delta P_{G3}, \Delta P_{G4}$  denote of governor output deviation for area 1, 2, 3, and

4;  $\Delta P_{C1}, \Delta P_{C2}, \Delta P_{C3}, \Delta P_{C4}$  refer to control input deviation of area 1, 2, 3, and 4;  $\Delta P_{tie-1}, \Delta P_{tie-2}, \Delta P_{tie-3}, \Delta P_{tie-4}$  stand for deviation in net tie-line power of area 1, 2, 3, and 4;  $u_1, u_2, u_3, u_4$  denote for input signal of area 1, 2, 3, and 4 respectively.

Matrix representation of the state space and output equations of the LFC in one area power system is as follows:

$$A_{ii} = \begin{bmatrix} -\frac{1}{T_{pi}} & \frac{K_{pi}}{T_{pi}} & 0 & 0 & -\frac{K_{pi}}{T_{pi}} \\ 0 & -\frac{1}{T_{Ti}} & \frac{1}{T_{Ti}} & 0 & 0 \\ 1 & 0 & -\frac{1}{T_{Gi}} & \frac{1}{T_{Gi}} & 0 \\ R_{Gi} \times T_{Gi} & 0 & T_{Gi} & T_{Gi} & 0 \\ -K_{Li} \times B_i & 0 & 0 & 0 & -K_{Li} \\ \sum_j T_{ij} & 0 & 0 & 0 & 0 \end{bmatrix} \quad (17)$$

$$A_{ij} = \begin{bmatrix} 0 & 0 & 0 & 0 & 0 \\ 0 & 0 & 0 & 0 & 0 \\ 0 & 0 & 0 & 0 & 0 \\ 0 & 0 & 0 & 0 & 0 \\ -2\pi T_{ij} & 0 & 0 & 0 & 0 \end{bmatrix} \quad (18)$$

$$H_{ij} (i \neq j) = \begin{bmatrix} 0 & 0 & 0 & 0 & 0 \\ 0 & 0 & 0 & 0 & 0 \\ 0 & 0 & 0 & 0 & 0 \\ 0 & 0 & 0 & 0 & 0 \\ -T_{ij} & 0 & 0 & 0 & 0 \end{bmatrix} \quad (19)$$

$$B_{ii} = [0 \ 0 \ 1/T_{Gi} \ 0 \ 0]^T \quad (20)$$

$$F_{ii} = [-K_{pi}/T_{pi} \ 0 \ 0 \ 0 \ 0]^T \quad (21)$$

$$C_{ii} = [1 \ 0 \ 0 \ 0 \ 0] \quad (22)$$

The parameters of LFC for the four areas interconnection power system are provided in Table 2.

Table 2. Parameters of LFC for the 4 areas interconnection power system [17]

Area 1		Area 2		Area 3		Area 4	
$K_{p1}$	120Hz/puMW	$K_{p2}$	112.5Hz/puMW	$K_{p3}$	125Hz/puMW	$K_{p4}$	115Hz/puMW
$T_{g1}$	0.08s	$T_{g2}$	0.072s	$T_{g3}$	0.07s	$T_{g4}$	0.085s
$T_{p1}$	20s	$T_{p2}$	25s	$T_{p3}$	20s	$T_{p4}$	15s
$T_{T1}$	0.3s	$T_{T2}$	0.33s	$T_{T3}$	0.35s	$T_{T4}$	0.375s
$R_{g1}$	2.4Hz/puMW	$R_{g2}$	2.7Hz/puMW	$R_{g3}$	2.5Hz/puMW	$R_{g4}$	2Hz/puMW

$K_{i1} = K_{i2} = K_{i3} = K_{i4} = 0.6$   
 $B_1 = B_2 = B_3 = B_4 = 0.425 \text{ puMW/Hz}$   
 $T_{12} = T_{13} = T_{14} = T_{21} = T_{23} = T_{31} = T_{32} = T_{41} = 0.545$   
 $T_{24} = T_{34} = T_{42} = T_{43} = 0$

### III. PROPOSED METHOD

This paper proposes the well-known optimal linear quadratic regulator (LQR) where the parameters of LQR are optimized by AIS via clonal selection to design load frequency control system.

#### A. Linear Quadratic Regulator (LQR)

An optimal control system based on LQR can be stated as a matter of practical control system then it is desirable to minimize an error signal function. Its application can be expressed in the form of a block diagram as illustrated in Figure 4. In order to obtain the necessary control signal  $u$ , amplifier controller  $K$  has to be obtained from LQR method. On the other hand, to keep the system stable, a stable controller is required. The plant is assumed to be a linear time-invariant (LTI) system which can be expressed in equation (12) and equation (13). Based on LQR theory, the control signal can be calculated as follows [8].

A quadratic criterion is chosen to optimize the problem with its performance index is as follows,

$$J(t_0) = \frac{1}{2} x^T(T) S(T) x(T) + \frac{1}{2} \int_{t_0}^T [x^T(t) Q x(t) + u^T(t) R u(t)] dt \quad (23)$$

where  $t_0$  is the initial condition of the system,  $S(T) \geq 0$  (positive semi-definite),  $Q \geq 0$  (positive semi-definite) and  $R > 0$  (positive definite) with the dimension  $Q^{n \times n}$  and  $R^{m \times m}$  respectively.  $S(T)$ ,  $Q$ , and  $R$  are symmetric shaped weights matrices.

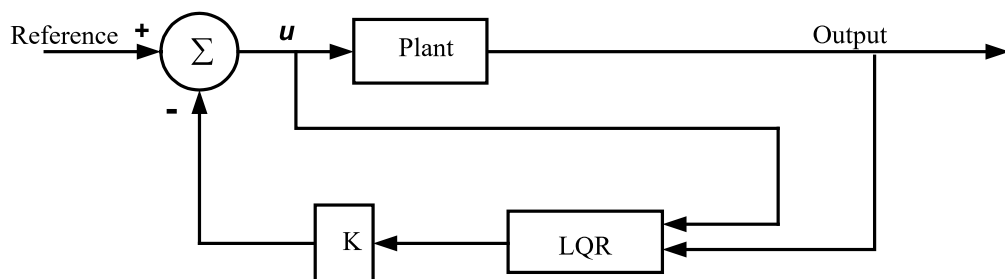

Figure 4. Block diagram control system

From optimal control theory, the gain and control input are given by the following equations:

$$K(t) = R^{-1}B^T S(t), \in \mathfrak{R}^{m \times n} \quad (24)$$

$$u(t) = -K(t)x(t) \quad (25)$$

$S(t)$  is the solution of the following Riccati equation:

$$-\dot{S} = A^T S + SA - SBR^{-1}B^T S + Q \quad (26)$$

The state space of the closed loop system is

$$\dot{x}(t) = (A - BK)x \quad (27)$$

In the closed-loop system matrix, Riccati equation becomes Joseph stabilized formulation as follows:

$$-\dot{S} = (A - BK)^T S + S(A - BK) + K^T R K + Q \quad (28)$$

and

$$J(t) = \frac{1}{2} x^T(t) S(t) x(t) + \frac{1}{2} \int_t^T \|R^{-1} B^T S x + u\|_R^2 dt \quad (29)$$

The performance index on  $[t, T]$  become:

$$J(t) = \frac{1}{2} x^T(t) S(t) x(t) \quad (30)$$

Gain matrix  $K$  in equation (25) which is obtained from equation (24) is substituted into equation (26) then fed it back to the system in order to obtain the minimum output.

## B. Artificial Immune System (AIS)

AIS is an optimization algorithm that mimics human immune system. The immune system has the function to protect the human body from the attack of foreign organisms. The immune system has the ability to differentiate between the normal components of our organism and the foreign organism that can cause harm. The foreign organisms are called antigens. The molecules called antibodies have an important role in the immune system response. The immune system response is specific to a certain antigen. When an antigen is known, those antibodies that best identify an antigen will proliferate by cloning. This process is called clonal selection principle. The principle of AIS via clonal selection is illustrated in Figure 5 [10, 11].

Three aspects of the clonal selection concept are described as follows:

- The new cells which are submitted to chromosomal mutation chemical mechanism are verily duplicated of their parents.
- Evacuation of newly differentiated lymph cell is bringing self-reactive sensory receptor.

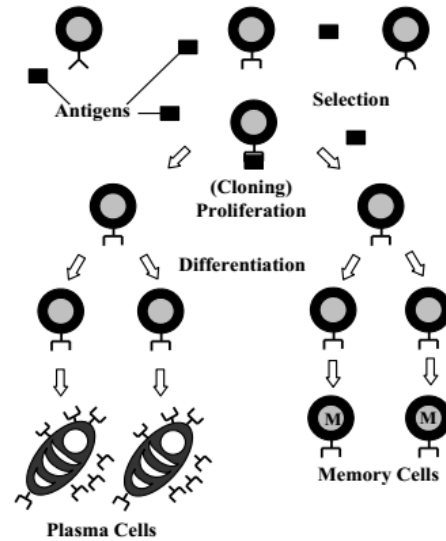

Figure 5. Artificial immune system (AIS) via clonal selection [11]

- Development and differentiation on contact of mature cells with antigens.

Sub population of bone marrow cells derived (B lymphocytes) will react by resulting antibodies (Ab) when an antibody is strongly matched to an antigen. Every cell confidential only has one type of antibody which is relatively specific for the antigen.

The antigen is identified by antibody with a particular affinity (degree of match), the B lymphocytes will be encouraged to proliferate (divide) and finally grow into terminal (non-dividing) antibody secreting cells, called plasma cell. The proliferation of the B lymphocytes is a mitotic process with the help of the cells divides themselves, producing a set of clones identical to the parent cell. The proliferation degree is proportional to the affinity level, i.e. the higher affinity levels of B lymphocyte, the more of them will be readily chosen for cloning and cloned in large numbers. In addition to proliferating and mature into plasma cells, the immune cells can distinguish into the long-lived memory cell. Memory cells distribute through the blood, lymph, and tissues, and when exposed to the second antigenic stimulus they commence into large immune cells (lymphocyte) capable of producing high affinity antibody specific antigen that once stimulated the primary response.

Pseudo code of AIS via clonal selection is described as follows [11]:

```

P ← rand(N, L)
While Not Stop condition Do
  For Each p of P Do // presentation
    affinity(p)
  End For
  P1 ← select(P, n) // clonal selection
  For Each p1 of P1 Do // clonal
    expansion
  End For
  C ← clone(p1)

```

```

End For
For Each c of C Do //affinity
  maturation
  hypermutation(c)
End For
For Each c of C Do // presentation
  affinity(c)
End for
P ← insert (C, n) // greedy selection
Pr ← rand (d, L)
P ← replace (P, D, Pr) // random
  replacement End While
    
```

The description of parameter for AIS via clonal selection is illustrated in Table 3.

**C. Implementation of Proposed Method**

In this section, the implementation of AIS via clonal selection to optimize the parameters of optimal LQR control is described. The scheme of optimal LQR control is illustrated in Figure 6.  $K_{LQR}$  in Figure 6 is a gain for feedback control obtained from the solution of equation (26). The AIS via clonal selection serves as a tool to adjust the values contained in Q and R matrices automatically which are a very important component of optimal LQR control. Equation (30) is used as the performance index ( $J$ ) of the system which will be minimize in this paper. This function is used as an affinity function in the optimization process. Flowchart of AIS via clonal selection utilized to select the optimal weighting matrices Q and R is shown in Figure 7.

Computation procedure of AIS via clonal selection to obtain optimal LQR parameters depicted in Figure 7 is as follows:

- a. *Generate initial population of antibody:*  
Generate initial antibody in population.

Table 3. AIS via clonal selection description

Parameter	Description
P	Antibodies' repertoire
N	Number of antibodies
N	Antibodies will be selected for cloning
L	Bit string length for each antibody
Nc	Number of clone produced by each selected antibody
D	Random number of antibodies to insert at the end of each generation. Best antibodies replace the d lowest affinity antibodies in the repertoire
Stop condition	Maximum generation
Affinity	Solution evolution
Clone	Duplication of selected bit string
Hypermutate	Modification of a bit string where the flipping of bit (it may be single bit or multiple bit) is governed by an affinity proportionate probability distribution

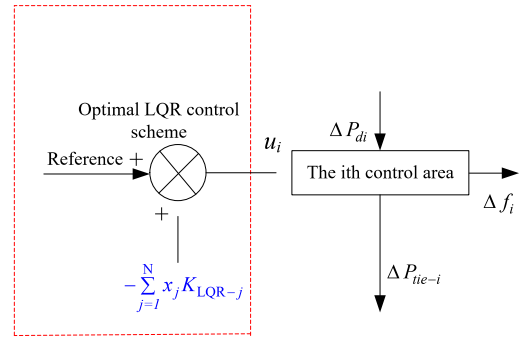

Figure 6. Optimal LQR control scheme

- b. *Calculate the objective function (affinity):* Performance index used as objective function is defined as follows:

$$J(t) = \frac{1}{2} x^T(t) S(t) x(t) \tag{31}$$

Subject to,

$$Q_{\min} \leq Q \leq Q_{\max}$$

$$R_{\min} \leq R \leq R_{\max}$$

where  $Q_{\min}$ ,  $Q_{\max}$ ,  $R_{\min}$ ,  $R_{\max}$  are 0, 100, 0, 10, respectively.

- c. *Select the best antibody by measuring their affinities:* Affinity is calculated by performance index in step b. Antibody with high affinity is the best antibody in this algorithm.
- d. *Clone best antibody:* Antibody with high affinity in population has higher probabilities will be cloned.
- e. *Take into account the population of clones to an affinity maturation scheme:* Antibody with lower affinity has higher probabilities will be hyper-mutated.

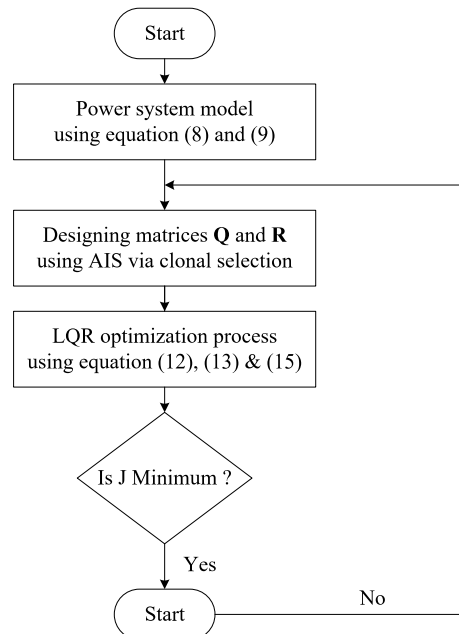

Figure 7. Proposed method

- f. *Re-select*: Every antibody is re-select based on step b.
- g. *Replace a new antibody to the previous antibody*: Antibody with lower affinity will be replaced.

#### IV. NUMERICAL STUDIES

All simulations are implemented on a desktop personal computer with a 2.20 GHz Intel Core i7 processor with 8 GB of RAM using the MATLAB software environment. We set the number of antibodies for AIS via clonal selection to 50, the maximum number of generations to 100 for all areas. The proposed method is examined by applying the change of load 0.01 p.u on area 1 as a disturbance. The convergence curves of AIS via clonal selection for the best affinity values on each area are illustrated in Figure 8.

Figure 8 shows that AIS via clonal selection reaches the convergence value at generation 19, 6, 43, 66 for area 1, 2, 3, and 4, respectively. Performance index (PI) value of optimal LQR control on each area is illustrated in Table 4. Although the maximum generation is set to 100, the AIS via clonal selection for area 1 to area 4 had reached earlier than a maximum generation for all areas.

The comparison of matrices Q and R obtained by Trial and Error (TEM) and AIS via clonal selection are listed in Table 5. Frequency deviation and control input deviation for area 1 to area 4 are depicted in Figure 9 (a) and (b) to 12 (a) and (b). From Figure 9 (a) and (b) to 12 (a) and (b), we can observe that the smallest overshoot and settling time are obtained by the proposed method. The values of overshoot and

Table 4.

PI Value of optimal LQR control using AIS via clonal selection

Area	$J$ (minimum)
1	0.7824
2	0.2053
3	0.4339
4	0.4092

Table 5.

Parameter of optimal LQR control

Area	Parameter of optimal LQR control			
	TEM		AIS via clonal selection	
	Q	R	Q	R
1	0.7	2.4	72.2633	1
	0.7		1.0000	
	0.7		27.3150	
	0.7		4.7557	
	0.7		3.0630	
2	0.7	2.7	14.2810	1
	0.7		94.0000	
	0.7		68.3249	
	0.7		8.0154	
	0.7		3.8331	
3	0.7	2.5	61.2065	1
	0.7		0	
	0.7		39.3815	
	0.7		25.3775	
	0.7		28.6025	
4	0.7	2	94.8829	1
	0.7		0	
	0.7		64.8708	
	0.7		23.3996	
	0.7		7.7552	

settling time in Figure 9 to Figure 12 are shown in Table 6 and Table 7. From Table 6 and Table 7, we can observe that the shortest settling time and minimum overshoot of frequency deviation

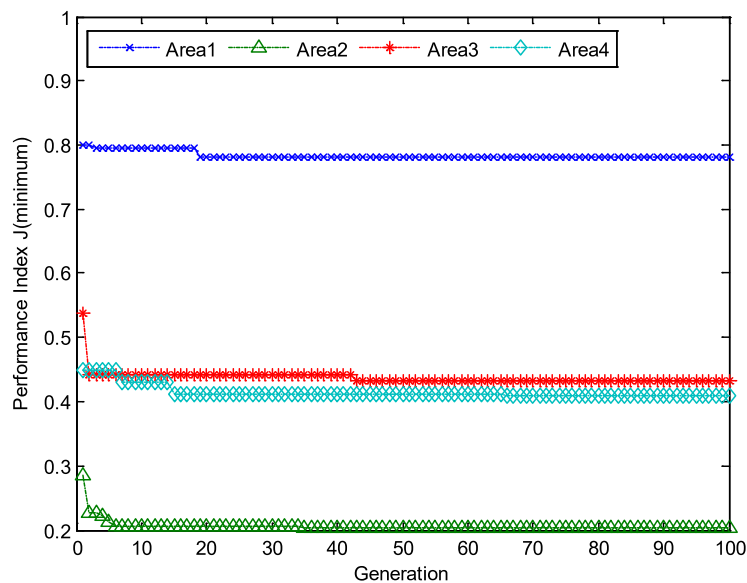
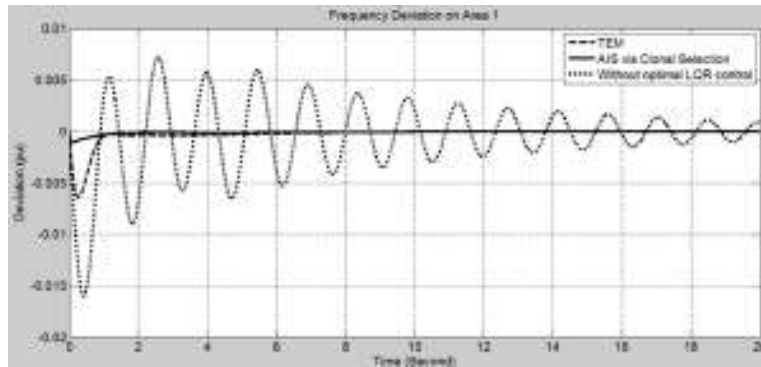

Figure 8. Convergence curve of AIS via clonal selection

can be obtained by AIS via clonal selection. System without optimal LQR control is the

worst; this system used manual gain feedback to produce signal control of the system. The best



(a)

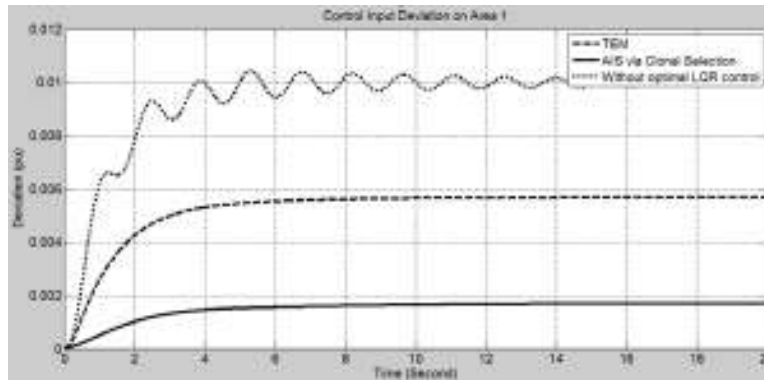

(b)

Figure 9. Frequency and control input deviations on Area 1: (a) Frequency deviation  $\Delta f_1$ ; (b) Control input deviation  $\Delta P_{C1}$

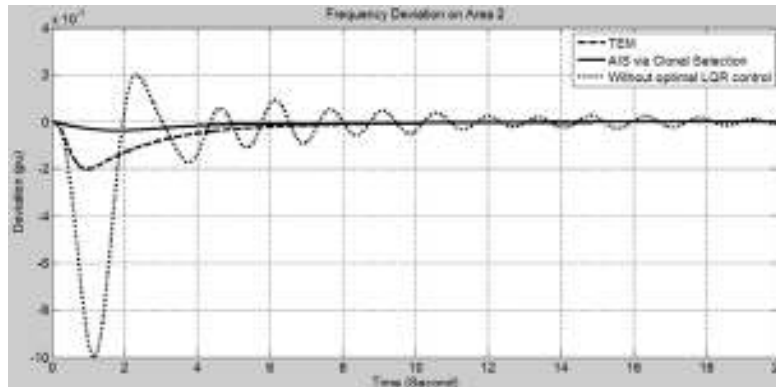

(a)

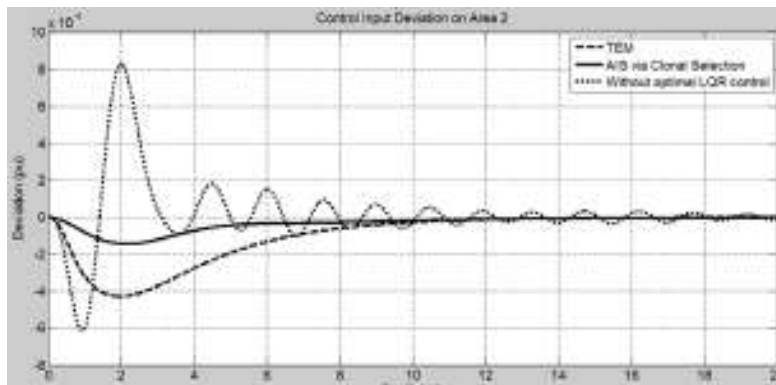

(b)

Figure 10. Frequency and control input deviations on Area 2: (a) Frequency deviation  $\Delta f_2$ ; (b) Control input deviation  $\Delta P_{C2}$

performance of the system is LFC equipped by the optimal control which was tuned by AIS via clonal selection. If the control input has a good

response, less overshoot and faster settling time then the response of the system will be as good as the control input.

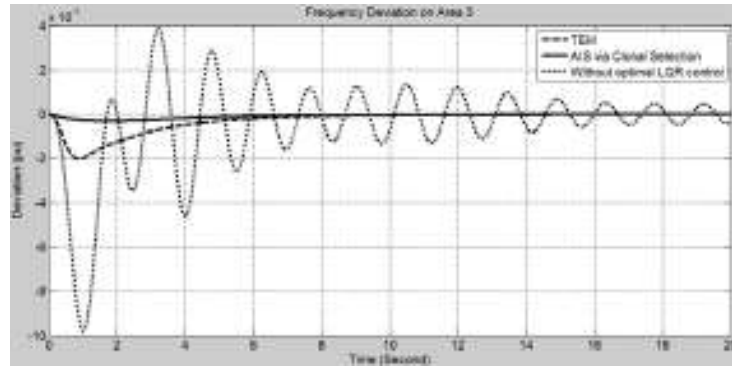

(a)

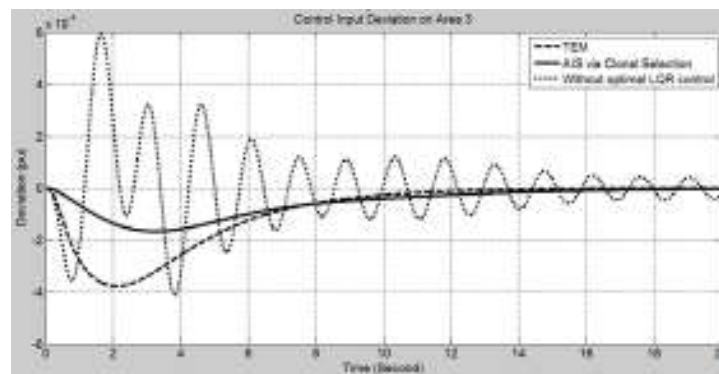

(b)

Figure 11. Frequency and control input deviations on Area 3: (a) Frequency deviation  $\Delta f_3$ ; (b) Control input deviation  $\Delta P_{C3}$

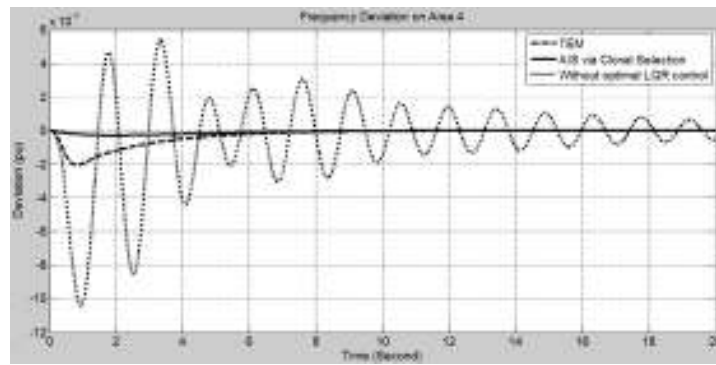

(a)

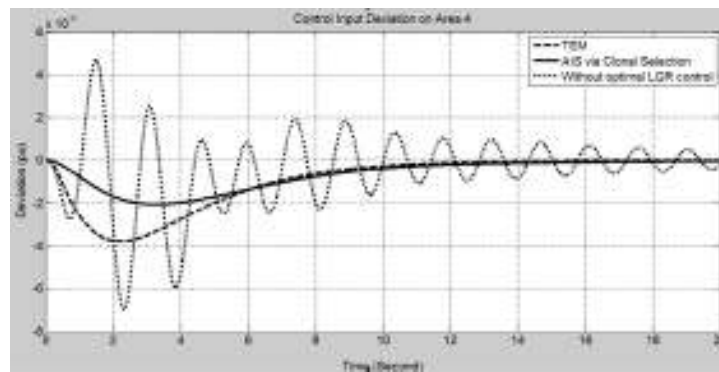

(b)

Figure 12. Frequency and control input deviations on Area 4: (a) Frequency deviation  $\Delta f_4$ ; (b) Control input deviation  $\Delta P_{C4}$

Table 6.  
Overshoot (p.u)

Output	Without Optimal LQR Control	Trial-Error Method (TEM)	Optimal Control AIS
$\Delta f_1$	-0.01583	-0.006319	-0.0009466
$\Delta f_2$	-0.009948	-0.001992	-0.0003705
$\Delta f_3$	-0.009625	-0.001986	-0.0003067
$\Delta f_4$	-0.01038	-0.001985	-0.0002702
$\Delta u_1$	0.01043	0.00565	0.001685
$\Delta u_2$	0.0008278	-0.000426	-0.000144
$\Delta u_3$	0.0005908	-0.0003785	-0.0001659
$\Delta u_4$	0.0004677	-0.0003806	-0.000215

Table 7.  
Settling time (second)

Output	Without Optimal LQR Control	Trial-Error Method (TEM)	Optimal Control AIS
$\Delta f_1$	>20	8.01	6.34
$\Delta f_2$	>20	7.58	5.32
$\Delta f_3$	>20	7.99	5.90
$\Delta f_4$	>20	7.67	5.12
$\Delta P_{C1}$	>20	9.89	13.57
$\Delta P_{C2}$	>20	10.67	7.13
$\Delta P_{C3}$	>20	17.26	15.11
$\Delta P_{C4}$	>20	16.11	14.29

## V. CONCLUSION

In this paper, load frequency control (LFC) for multi-area power system network is presented. The impact of LFC control method to maintain the frequency fluctuation caused by load change is examined. An application of AIS via clonal selection to determine the optimal LQR control parameters is provided. The advantage of the proposed method is that it can adjust automatically the parameters of optimal LQR control when there is load change on power system network. Although trial error method (TEM) is simple, it is difficult to obtain optimal control performances. Also, it takes a long time to select the best optimal LQR control parameters. It is clear that optimal LQR control optimized by AIS via clonal selection is more suitable to improve the system dynamic than TEM.

## ACKNOWLEDGEMENT

The authors are grateful to all anonymous reviewers for their valuable suggestions in order to improve the quality of our paper.

## REFERENCES

- [1] R. W. W. Atmaja et al., "Optimal design of PID controller in interconnected load frequency control using hybrid differential evolution- particle swarm optimization algorithm," in *Proceedings of 2014 Seminar on Intelligent Technology and Its Applications*, 2014.
- [2] I. Robandi, *Desain sistem tenaga modern*, Penerbit Andi Yogyakarta, 2006.
- [3] M. A. Mahmud, "An alternative LQR-based excitation controller design for power systems to enhance small-signal stability," *International Journal of Electrical Power and Energy Systems*, Vol. 63, pp. 1-7, 2014.
- [4] S. K. Pandey et al., "A literature survey on load frequency control for conventional and distribution generation power systems," *Renewable and Sustainable Energy Reviews*, Vol. 25, pp. 318-34, 2013.
- [5] Ibraheem et al., "AGC of two area power system interconnected by AC/DC links with diverse sources in each area," *International Journal of Electrical Power and Energy Systems*, Vol. 55, pp. 297-304, 2014.
- [6] M. R. Sathya and M. M. T. Ansari, "Load frequency control using Bat inspired algorithm based dual mode gain scheduling of PI controllers for interconnected power system," *International Journal of Electrical Power and Energy Systems*, Vol. 64, pp. 365-74, 2015.
- [7] X. Hao and S. Cai-xin, "Artificial immune network classification algorithm for fault diagnosis of power transformer," *IEEE Transaction on Power Delivery*, Vol. 22, pp. 930-935, 2007.
- [8] I. Idris and A. Selamat, "Negative selection algorithm in artificial immune system for spam detection," in *Proceedings of the 2011 IEEE Software Engineering*, pp. 379-382, 2011.
- [9] Y. Zhuang et al., "Information security risk assessment based on artificial immune danger theory," in *Proceedings of the 2009 IEEE Computing in the Global Information Technology*, pp. 169-174, 2009.
- [10] M. W. Yaw et al., "Optimization of the multi-flow rate mode selection for pneumatic dispensing valve system using clonal selection based artificial immune system algorithm," in *Proceedings of the*



- 2011 IEEE Control System, Computing and Engineering, pp. 327-331, 2011.
- [11] L. N. de Castro and J. Timmis, "Artificial immune system: a novel paradigm to pattern recognition, " in *Proceeding of SOCO*, University of Paisley, UK, pp. 67-84, 2002.
- [12] E. Hart et al., "Producing robust schedules via an artificial immune system," in *Proceedings of the International Conference on Electronic Commerce 1998 (ICEC'98)*, April 6-9, 1998.
- [13] E. Hart and P. Ross, "An immune system approach to scheduling in changing environments," in *Proceedings of The Genetic and Evolutionary Computation Conference 1999 (GECCO'99)*, July 13-17, 1999.
- [14] Y. Li et al., "Improved immune algorithm for reactive power optimization," in *Proceeding of 2013 IEEE Instrumentation and Measurement, Sensor Network and Automation*, pp. 458-462, 2013.
- [15] Z. Haybar et al., "Dynamic power system stability improvement on single-machine power system using optimal artificial immune system power system stabilizer (OpAISPSS)," in *Proceedings of Seminar Nasional Efisiensi dan konversi Energi*, 2006.
- [16] H. Maryono et al., "Coordination of power system stabilizer (PSS) and thyristor controlled series capacitor (TCSC) damping controller using AIS via clonal selection," in *Proceeding of Seminar on Intelligent Technology and Its Applications (SITIA)*, 2006 (In Indonesian Language).
- [17] T. C. Yang et al., "Decentralized power system load frequency control beyond the limit of diagonal dominance," *International Journal of Electrical Power and Energy Systems*, Vol. 24, pp. 173-184, 2002.